



Fig. 1

1. Important Information

Dear Customer,

You have purchased an instrument that was manufactured in our company, which is certified according to DIN EN ISO 9001.

The pressure controllers are manufactured according to the valid standards. Their designs, dimensions and materials represent the state of engineering at the time of printing.

We reserve the right to change and replace components without further notice.

The integrated pressure sensors are, unless otherwise agreed, calibrated in compliance with test certificate 3.1 according to DIN EN 10 204, and thus traceable to a national standard.

Please read these operating instructions carefully before taking the precision pressure controller/calibrator DPC 3800 HD (⇒ fig. 1) into operation.

The following operating instruction was composed with due care. The following chapters provide you with all information necessary for a safe handling.

Please ensure that all persons, who operate the device, have read and understood these operating instructions.

It is, however, not possible to take into account all versions and possible fields of application in this manual.

If you have any questions regarding a special application, regarding the devices, storage, mounting or operation, please contact us as manufacturer or the supplier.

Should a reason for complaint however arise, please return your device with a detailed description of faults to our factory.

For special versions, please note the specifications indicated on the delivery note.

Please support us in improving this operating instruction. We will gladly accept your advice.

 All applications according to regulations are explicitly stated, any other application is considered improper use!

Both ARMATURENBAU GmbH and MANOTHERM Beierfeld GmbH do not assume liability for damage that arises from incorrect use of the device or from disregard of the information contained in this manual.

Please keep the operating instructions in a safe place to draw on it as and when required.

Do not tamper with the device on your own. Otherwise, all warranty claims will be void.

No reproduction of this operating instruction (in whole or in part) is allowed.

Not all functions that are depicted and described in this manual are available for every instrument version.

Firmware - Manual - Version Key

Manual	Firmware
V 1.1	BBVO.959BV



Operating Instructions

Precision Pressure Controller/Calibrator DPC 3800 HD

2.	Contents	Page
1.	Important Information	1
2.	Contents	2
3.	General Information	2
3.1	Pictographs Used in This Manual	3
4.	General Safety Instructions	3
4.1	Operator's Obligation to Exercise Diligence	4
4.1.1	Personnel Qualification	4
4.2	Basic Safety Instructions	4
4.3	Personal Protective Equipment	4
4.4	Safety Instructions Concerning the Operation	5
4.5	Safety Markings on the Pressure Controller	5
4.5.1	Explanation of Symbols	5
4.6	Information on the Electromagnetic Compatibility (EMC)	5
4.6.1	EN 55 011 (or CISPR 11)	5
5.	Device Description	5
5.1	Software License	6
6.	Product Description	6
6.1	Intended Use	6
6.2	Design	6
6.3	General Description of Function	7
6.4	General Instructions on the Interface Communication	7
6.4.1	Ethernet Interface	7
6.4.2	RS-232 Interface	7
6.4.3	IEEE-488.2 Optional Interface	7
6.4.4	DPC Interface Configuration	7
6.4.5	RS-232 Socket 9 PIN Sub-D	8
6.5	Operating Principle of the Multiple Range Version	8
7.	Technical Data	8
8.	Transport, Packing and Storage	9
8.1	Transport	9
8.2	Packing Materials Handling	9
8.3	Storage	9
9.	Installation – Configuration and Function	10
9.1	Introduction	10
9.2	Scope of Delivery	10
9.3	Unpacking	10
9.4	Setting Up	10
9.5	Pressure Connections	10
9.6	Recommendation Concerning the Pressure Piping	10
9.7	Electrical Connections of the Control Unit	10
9.7.1	Connection of the Mains Input Socket	11
9.7.2	Connection of the Interfaces	11
9.7.3	Connection of the Relay Outputs	11
10.	Commissioning and Operating	11
11.	Operation	11
11.1	Preparations	11
11.2	Switching On and Off	12
11.3	Basic Settings	12
11.4	Menu Navigation and Buttons	12
11.4.1	Main Menu	12
11.4.2	Set Up Menu	14
11.5	Control	16
11.6	External Operation	16
11.7	Service Menu	17
12.	Maintenance	18
13.	Dismounting and Disposal	18
14.	CE Conformity	19
15.	Common Units and their Conversion Factors	20
16.	Troubleshooting Measures	21
16.1	Description of Faults and Measures	21
17.	Annex	22
17.1	DPC Commands	22
18.	Declaration of Conformity	26

3.	General Information
•	The manual is aimed at specialists and semi-skilled personnel.
•	Please read the instructions carefully before carrying out any operation and keep the specified order.
•	Thoroughly read and understand the information in chapter 4 "General Safety Instructions".

If you have any problems or questions, please contact your supplier or contact us directly at:

ARMATURENBAU GmbH
Manometerstraße 5
D – 46487 Wesel-Ginderich
Tel.: +49 2803 9130 – 0 // Fax: +49 2803 1035
mail@armaturenbau.com

MANOTHERM Beierfeld GmbH
Am Gewerbepark 9
D – 08344 Grünhain-Beierfeld
Tel.: +49 3774 58 – 0 // Fax: +49 3774 58-545
mail@manotherm.com

3.1 Pictographs Used in This Manual

In this manual, pictographs are used as hazard warnings.

Particular information, instructions and restrictions designed for the prevention of personal or substantial property damage:



WARNING! Is used to warn you against an imminent danger that may result in personal injury or death.

IMPORTANT! Is used to warn you against a possibly hazardous situation that may result in personal, property or environmental damage.

CAUTION! Is used to draw your attention to important recommendations to be observed. Disregarding them may result in property damage.



DANGER! This symbol is used for hazards generated by electric current. Disregarding these safety instructions may result in serious or fatal injuries.



Passages in the text containing **explanations, information or advice** are highlighted with this pictograph.



The following symbol highlights **actions** you have to conduct or **instructions** that have to be strictly observed.

4. General Safety Instructions

Please read this operating instruction thoroughly before operating the pressure controller DPC 3800 HD. Disregarding the containing warnings, especially the safety instructions, results in a risk of fatal injury. Severe personal injuries as well as property damage may arise.

Any use of the pressure controller DPC 3800 HD diverting from or exceeding the set applications according to the regulations is not allowed.

It is required to comply with all technical specifications of the pressure controller according to this manual.

The precision pressure controller is to be handled with care. The permissible ambient conditions according to data sheet 10462 are to be kept.

The device is supplied with hazardous voltages via mains cable. Even after the disconnection from the power supply, dangerous voltages may be temporarily present due to capacitances.



IMPORTANT! Before the mounting, commissioning and operating it is necessary to ensure that the device is suitable concerning pressure range, version and specific measuring conditions.

Do not open the device.



DANGER! The device may only be opened by trained and qualified personnel. There is a risk of an electric shock.

Transporting the device from a cold to a warm environment, condensation may result in a failure of the function. In such a case, make sure the device temperature has adjusted to the ambient temperature before putting it into operation again.

If faults cannot be corrected with the help of this operating instruction, the device has to be decommissioned instantly and secured against unintentional commissioning.

The manufacturer shall not be held liable for any damage due to misuse of the device. Repairs shall only be performed by the manufacturer. Any modifications or changes to the device are not permissible.

4.1 Operator's Obligation to Exercise Diligence

The pressure controller DPC 3800 HD was designed and manufactured following a careful selection of standards to be complied with as well as further technical specifications. It therefore complies with the state of the art and guarantees maximum safety. This safety is achieved in industrial practice only if all necessary measures are taken. The necessary measures are subject to the due diligence of the user of the pressure controller DPC 3800 HD.

In particular, the user shall ensure that

- the pressure controller DPC 3800 HD is only used according to the regulations (⇒ chapter 6 "Product Description").
- there exist proved safety mechanisms, which avoid any risks for personnel or devices, especially test items (UUT) in case of undue pressurisation or leakage of the applied media.
- the device and all components involved are only operated when in a flawless and fully functional condition, when the installation and commissioning was carried out correctly and when regular maintenance is conducted.
- the persons, who operate the pressure controller have access to this manual at all times and that they have read and understood this manual.
- the pressure controller shall only be mounted, commissioned, maintained and put out of operation by authorised, trained and instructed personnel who are able to independently recognise potential hazards.
- the pressure controller must always be handled with the care necessary for an electronic precision measuring device.

4.1.1 Personnel Qualification



WARNING! Risk of injury in case of insufficient qualification!

Personnel, responsible for mounting, commissioning, operating and decommissioning has to be adequately qualified for these tasks.

Qualified personnel are those persons, who are familiar with setting up, mounting, commissioning and operating this pressure controller DPC 3800 HD and those, who have an appropriate qualification corresponding to their function.

Attention should be paid to directions concerning occupational safety and regulations of the employer's liability insurance association.

4.2 Basic Safety Instructions

Sound and safe operation of the pressure controller requires proper transport, professional storage, set-up, mounting and intended use. A careful operation and scheduled interval maintenance is required for an electronic precision measuring device.

In the case of an error, a high medium pressure or vacuum may be on the input and output connections. An unregulated release of gas pressure poses a serious danger for humans and the environment.

If the display is damaged, please pay attention to glass fragments since you might cut or injure yourself.



Further important safety instructions can be found in the various sections of this operating instruction.

4.3 Personal Protective Equipment



WARNING! High sound pressure due to outpouring medium.



Wear ear protection!



When working with and on the device, wear safety glasses!

4.4 Safety Instructions Concerning the Operation

Before pressurisation of the pressure controller, all involved components shall be in a flawless and fully functional condition. The attached components shall be suitable for the applied maximum pressure. Check the screw fittings for leaks and that they are firmly seated.

The used medium shall meet the requirements according to the operating instruction.

Maintenance, cleaning and service works on the pressure controller shall always be carried out under voltage-free and pressure-free conditions of the system.

Ensure that a safe pressure release is possible on the rear side of the pressure controller.

The limit values for voltage and current must not be exceeded.

4.5 Safety Markings on the Pressure Controller

4.5.1 Explanation of Symbols



This operating instruction is to be read prior to mounting and commissioning by all means!



With the CE marking, the pressure controller DPC 3800 HD complies with the current European Directives.



For disposal, return the product to the manufacturer or bring it to a designated collection facility. See EU-Directives 2012/19/EU.

4.6 Information on the Electromagnetic Compatibility (EMC)

4.6.1 EN 55 011 (or CISPR 11)



This is a device of Class A for interference emission and is designed for use in an industrial environment.

In other environments, e.g. living and business areas, it might possibly interfere with other devices. In this case, the user may be required to take appropriate corrective action.

5. Device Description



Fig. 5

Features/Specialties:

The pressure controller DPC 3800 HD (⇒ fig. 5) features a wide range of industrial capabilities.

- Pressure controller with precision pressure sensor
- Customised configurations of the pressure controller possible
- Very high measuring rate
- Colour touchscreen, LED backlight
- Easily calibrated
- Modular construction
- Fully digital measuring instrument
- Automatic creation of test certificates via optional calibration software DynaCal

Instrument Versions:

Please refer to the delivery note of your device for detailed information on the range of function and on the scope of delivery.

Operating Instructions

Precision Pressure Controller/Calibrator DPC 3800 HD

5.1 Software License

This product contains intellectual property, i.e. software programmes that are licensed for use by the end user/customer (hereinafter "end user").

This is not a sale of such intellectual property.

The end user shall not copy, disassemble or reverse compile the software programme.

The software programme is provided to the end user "as is" without warranty of any kind, either expressed or implied, including, but not limited to, warranties of merchantability and fitness for a particular purpose. The entire risk of the quality and performance of the software programme is with the end user.

ARMATURENBAU GmbH and MANOTHERM Beierfeld GmbH shall not be held liable for any damage suffered or incurred (including, but not limited to, general, special, consequential or incidental damage including damage for loss of business profits, business interruption, loss of business information and the like), arising from or in connection with the delivery, use and performance of the software programme.

6. Product Description

6.1 Intended Use

The controller DPC 3800 HD is equipped with a precision sensor. The position of the pressure connections may vary depending on the version. Due to a measurement uncertainty of 0.01 % FS of the entire measuring chain and its control stability of 0.005 % FS, this controller DPC 3800 HD is suited for the automatic calibration of pressure measuring instruments.



WARNING! The drive component of the DPC 3800 HD shall only be used with clean dry air or nitrogen. Workshop air shall be avoided and according to Article 2 Section 2 of the Directive 67/548/EEC it is essential to avoid using hazardous media as pressure medium.

In the hydraulic component, the medium, which was filled upon delivery (which is normally water), shall be used preferably.

Strictly adhere to the indicated limit values of the individual pressure sensors as well as all other technical specifications listed in this manual.

Extremely fast pressure change rates pose a danger for the sensor technology. Especially, if they result in an internal pressure (even for a short time), which exceeds the upper range value of the controller, since they mean a high mechanical stress for the sensors. A protection by means of the integrated overload device cannot be guaranteed in such a case, since there is a certain response time required for actuation.

All integrated pressure sensors are equipped with a calibration certificate for the entire measuring chain (⇒ enclosure). Improper handling or exceeding the maximum pressure range might possibly require recalibration and adjustment. In this case, please return the device immediately to the manufacturer.

The device is not suitable for the operation in potentially explosive areas. The DPC 3800 HD is no safety component according to the pressure equipment directive and must not be used as such. If not used according to this operating instruction, no safe operation of the DPC 3800 HD is ensured.

The operator of the device, not the manufacturer, is liable for any personal and material damage that arises from unintended use!

6.2 Design

The precision pressure controller DPC 3800 HD is divided into a control module and a hydraulic module. The control module is available as desktop case or optionally as 19" rack mounting with side panels including mounting kit. The hydraulic module is housed in a separate steel cabinet. We recommend the installation of the components in a stationary or mobile work station (⇒ data sheet 10462). The main components of the precision pressure controller DPC 3800 HD are the measuring and control electronics, three or five magnetic valves, evaluation unit and the interfaces RS-232, Ethernet and touchscreen.

6.3 General Description of Function

- One temperature compensated high-precision pressure sensor
- The DPC 3800 HD controls (positive) pressure changes of 10 % FS at a test volume of 200 ml within ≤ 10 seconds
- Pressure ranges >40 MPa measuring uncertainty ($K=2$) 0.01 % FS
- Remote operation via RS-232 or Ethernet
- Optional emulation of other standard controllers

6.4 General Instructions on the Interface Communication

For integration in existing systems an RS-232, Ethernet or optionally IEEE-488.2 interface or an analogue output is available.

6.4.1 Ethernet Interface

The Ethernet communication port enables the DPC 3800 HD to communicate with computers via 10/100 Base-T-Specifications.

Please consult your network administrator before connecting the device with your network to avoid conflicts with existing IP addresses.

Ethernet communications are transmitted via RJ-45 standard cable. Prior to the first use of Ethernet communication, the four parameters IP, Net mask, Gateway and Port must be set. These are configured in the communication set up menu.

6.4.2 RS-232 Interface

When using the RS-232 interface, a cable must be connected directly from the instrument to a suitable port on the computer ('point to point' link). Table 6.4.5 shows the PIN connections for the 9-pin D-type, RS-232 connector, the RS-232 control signals, and the relationship between the computer and pressure connection. The device is configured as data terminal equipment (DTE).

6.4.3 IEEE-488.2 Optional Interface

The connection of the IEEE-488.2 interface is designed as a 24-pin IEEE-488 socket. The manufacturer of the IEEE-488 interface board provides software to allow communication between the DPC 3800 HD and various programming languages.

6.4.4 DPC Interface Configuration

Connector pin assignment DPC 3800 HD (option push button)

PIN	Configuration	Description
1	Vent 1 CNT	valve 1 control output cut off control unit
2	Vent 1 GND	valve 1 ground
3	Vent 2 CNT	valve 2 control output exhaust UUT (test item)
4	Vent 2 GND	valve 2 ground
5		
6		
7		
8		
9	Control + 24 V	supply for control gate input
10	Control Input	control gate input (pedal button)

USB Interface:

The USB 2.0 FS-connection on the rear side of the device is a socket type USB-B. It is needed for service purposes only.

DPC Commands:

⇒ Chapter 17 "Annex"

Operating Instructions

Precision Pressure Controller/Calibrator DPC 3800 HD

6.4.5 RS-232 Socket 9 PIN Sub-D

PIN	Configuration	Description
1		
2	RX	transmission (wire colour yellow)
3	TX	receive path (wire colour green)
4		
5	signal ground	(wire colour brown)
6	DSR	dataset ready (wire colour white)
7		
8		
9		

6.5 Operating Principle of the Multiple Range Version

The pressure controller DPC 3800 HD is constructed as a two-stage pressure generator, with the first stage being a 10 bar gas pressure regulator that drives a pneumatic high pressure amplifier. The hydropneumatic high pressure amplifier increases the settled gas pressure by a fix factor:

- 1: 40 at 40 MPa
- 1: 60 at 60 MPa
- 1:100 at 100 Mpa

An electrical pre-filling pump generates a hydraulic admission pressure of approximately 7 bar. Afterwards, the pressure is adjusted further via the hydraulic amplifier. The DPC 3800 HD has one pressure range.

7. Technical Data

Gauge pressure (bar)	0 – 400; 0 – 600; 0 – 1000
Pressure units	23 and 1 freely programmable
Instrument version	desktop case and hydraulic cabinet
Weight	approx. 96 kg (211.64 lb)

Display	
Screen division	actual value, reference value, steps
Resolution	6 digits
Keyboard	colour touchscreen
Warm-up time	< 10 minutes
Response time	approx. 10 ms
Pressure ranges	1 pressure range
Pressure connection	G½ quick clamp adapter
Media	standard: water (conductivity 100–300 mS) optional: oil
Overrange protection	140 % of the pressure range optional: mechanical overpressure protection
Power supply	auxiliary energy 88 – 264 V AC, 47 – 63 Hz

Permissible Ambient Conditions	
Operating temperature	+10 to +40 °C (+50 to +104 °F)
Storage temperature	0 to +70 °C (+32 to +158 °F) consider frost protection when water is the medium
Relative humidity	0 to 95 % r. h. (non-condensing)
Compensated temperature range	+15 to +35 °C (+59 to +95 °F)

Communication	
Interfaces	RS-232, Ethernet optional: IEEE-488.2
Switching outputs	24 V DC PWM or TTL level

Command sets	DPC 3800 HD, alternative command sets possible, alignment to existing HOST software upon request
Approvals and certificates	EMC directive 2014/30/EU, EN 61 326-1 emission (group 1, class A) and stability (industrial sector)
Calibration certificate 3.1	according to DIN EN 10 204, optionally internationally traceable calibration certificate (DAkkS)

Operating Instructions

Precision Pressure Controller/Calibrator DPC 3800 HD

Dimensional Data in mm / inch

Recommended Instrument Version: Calibration Work Station

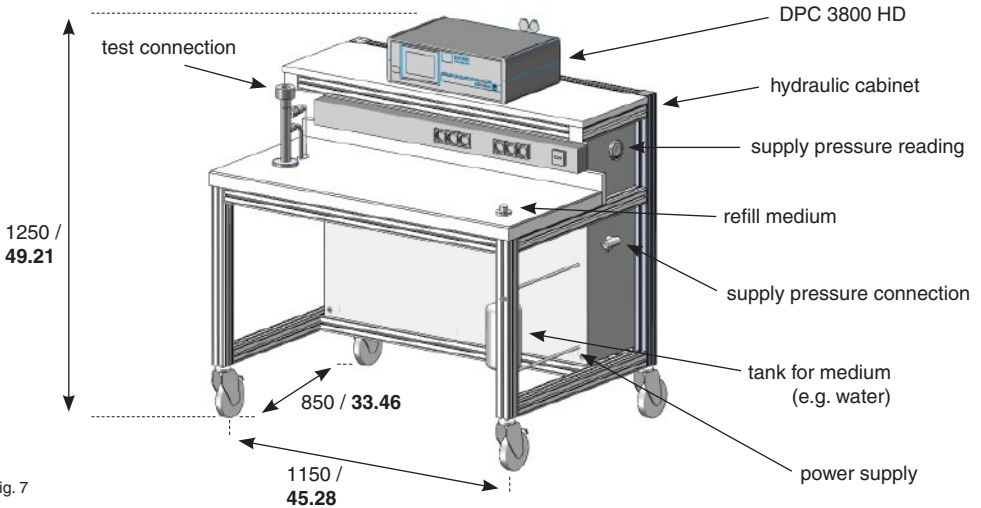

8. Transport, Packing and Storage

8.1 Transport

The system shall be clean and free of dirt before shipping. This is especially important if the medium is health-damaging, e.g. toxic, corrosive, carcinogenic or radioactive.

Transport and packing of the unit shall be carried out by trained personnel only.

8.2 Packing Materials Handling

The packing shall only be removed immediately before mounting the DPC 3800 HD.

8.3 Storage

The system shall be clean and free of dirt before storage. This is especially important if the medium is health-damaging, e.g. toxic, corrosive, carcinogenic or radioactive.

The storage location shall comply with the following conditions:

- Ambient temperature: 4 to 70 °C (39.2 to 158 °F)
- Humidity: 35 to 85 % relative humidity (non-condensing)

Avoid the following influences:

- Direct sunlight or vicinity to hot objects
- Mechanical vibration/mechanical shock (by putting it down hard)
- Soot, vapour, dust and corrosive gases
- Potentially explosive environments, flammable atmospheres

Operating Instructions

Precision Pressure Controller/Calibrator DPC 3800 HD

9. Installation – Configuration and Function

9.1 Introduction

The following chapter contains recommendations concerning the initial installation of the DPC 3800 HD. The installation is carried out as follows: unpack the device, set it up at an appropriate place, connect it, switch it on and configure the system if necessary.

9.2 Scope of Delivery

Apart from additional parts you may have ordered, the delivery consists of:

- Operating unit with the control electronics
- Hydraulic cabinet with the pressure regulator
- External precision pressure sensor

9.3 Unpacking

Please unpack all components of the device carefully and check the individual parts for damage. Immediately report any damage to the shipping company.

9.4 Setting Up

The installation site shall comply with the following conditions:

- Ambient temperature: 15 to 35 °C (59 to 95 °F)
- Humidity: 0 to 95 % relative humidity, without condensation
- Flat, horizontal position; secure and fixed working surface (desktop version) or proper installation in a solid 19" mounting frame/4HE (19" rack mounting)
- During operation, pressure escapes at the rear side of the device. Therefore, make sure that personnel has no access to the rear side during operation as well as to the vent opening in case of piped **Vent/Low Supply** port.

Avoid the following influences:

- Direct sunlight or vicinity to hot objects
- Unstable installation position or highly inclined installation position
- Mechanical vibrations
- Proximity to disturbing sources with strong electromagnetic fields, such as high voltage appliances, mobile phones or power lines
- Soot, vapour, dust and corrosive gases
- Potentially explosive environments

Pressure supply requirements:

- Stable supply pressure: slightly above the full scale value of the controller
- Permissible media: dry, clean air or nitrogen
- Vacuum: at least 50 litres/min (if required)

9.5 Pressure Connections

(⇒ fig. 7 and 9.5)



Fig. 9.5

Supply and Test port:

The **Test** port is designed as pressure column with quick release fastener (⇒ fig. 9.5).

Below the label "**Supply**" is the pressure connection for the supply pressure, which should be slightly higher than the full scale value of the controller (the connection is on the right side of the hydraulic cabinet).

9.6 Recommendation Concerning the Pressure Piping

The user must ensure that the used media are available in clean and dry form. If necessary, the sensors have to be protected by using sediment bowls, particle filters or humidity filters.

9.7 Electrical Connections of the Control Unit

The electrical installation has to be carried out according to the following instructions while observing all relevant regulations. It is to be carried out by personnel, who are familiar with the safety regulations for working on electrical plants and who can work according to them.

9.7.1 Connection of the Mains Input Socket

Before connecting the mains input socket, make sure that the mains voltage corresponds to the specification of the power supply unit. Switch off the device before connecting it with the mains. Only the provided mains cable should be used. The provided 3-pin mains cable is equipped with a protective conductor. Hence, operate the device only from a three-pin socket and always make sure that the earth conductor is properly connected.

The mains input socket is to be connected, according to the regulations, to a power supply with the provided country-specific connection cable, which is within the stipulated specification (⇒ chapter 7 "Technical Data").

9.7.2 Connection of the Interfaces

The interface cables must not be longer than 3 m and must be laid separate from cables with voltages >60 V. Devices, which are connected to the interfaces, have to comply with the standard IEC 60 950.

RS-232 Interface:

The RS-232 interface is designed as a 9-pin SUB-D socket and is to be connected as required according to the regulations with the cable mentioned below or a 9-pin 1:1 cable of similar quality:
3 m Data Extension Cable; DB9 Male/DB9 Female.

IEEE-488 Interface:

The connection of the IEEE-488 interface is designed as a 24-pin IEEE socket and is to be connected as required according to the regulations with the cable mentioned below or a cable of similar quality:
2 m IEEE-488-2 MPB CABLE.

9.7.3 Connection of the Relay Outputs

When connecting the relay outputs, the national installation regulations (e.g. Germany: VDE standard) and the Appliance Safety Law are to be observed and followed. The limit values of the relays for current and voltage must not be exceeded. The relays must not have any direct or indirect influence on critical processes.

10. Commissioning and Operating

Prior to switching on the device, it must be ensured that the device was installed according to the instructions of the previous chapter and that all connections installed are fitted or carried out according to the regulations. It is necessary to ensure that all specifications, such as supply voltage, supply pressure, operating temperature, humidity, specified media and pressure range are met. Rapid temperature changes might cause condensation within the device. In such a case, allow the device to acclimatise. Before pressurising, appropriate protective measures must be taken to ensure that the device or a test item will not be overloaded. When working on or with the device, safety glasses must be worn. When the supply pressure exceeds 40 bar, ear protection must be worn. When working with inert gases, these might leak. This is why premises, in which the DPC 3800 HD is operated, need sufficient air ventilation systems.



WARNING! Pressure can accelerate loose components in a hazardous manner.

The device is configured ex-works in such a way that the individual measured value display (1 window / MEASURING mode) appears on the screen.

After thermal balancing with the installation place, the controller is immediately ready for operation. However, in order to achieve the ideal precision of the system, the device should be switched on about 15 minutes prior to its use.

11. Operation

11.1 Preparations



Instrument displays may differ from the figures in this manual, depending on the selected instrument configuration.



Please ensure that electrical cables and pressure pipes comply with the installation requirements in chapters 9 and 10.

A proper connection of the required components will be accomplished by following the directions below:

- Make sure that the power switch on the front side is turned off (push the lower part of the **red flip switch**).
- Connect the supplied mains cable to the power supply.
- Check the pressure hoses of your pressure supply for damage as well as infiltrating dirt and moisture.
- Connect the pressure supply. Depending on the design, this connection is on the right or the left side of the hydraulic cabinet. As measured by the stationary pressure sensors, a pressure supply about 10 % above the highest installed pressure level shall be connected in order to guarantee complete control. A compressor is available separately.
- Connect a filter to the **Vent** port. If no filter is used, this connection must be left open to atmosphere and external pressure must not be applied.
- Connect a calibration object or a device for pressure testing to the **Test** port. A test item (UUT) is available separately.



CAUTION! The test item might be damaged due to overpressure. Therefore, please bear in mind the permissible maximum pressure of the test item during control and make necessary adjustments on your pressure controller (⇒ chapter 11.4.2).

- Please test the device prior to use.
- Get an overview and acquaint yourself with the complete procedure before starting a process on a component or system.
- For further connection options for external operation please refer to chapter 11.6.

11.2 Switching On and Off

After completing all preparations, turn on the device by pressing the **red flip switch** on the front side of the device. Wait a few seconds for the main menu to appear on the screen (⇒ chapter 11.4.1). The device is now ready for operation.

Before switching off the device, we recommend to release the pressure, which might be within the device, by venting it. To do so, press the **“Vent”** button in the main menu via touchscreen (⇒ chapter 11.4.1). When the device is vented successfully, turn it off by pressing the **red flip switch** on the front side of the device.



CAUTION! Protect your device from a too high permanent load. If you are not going to use the device for a considerable time, please turn off the pressure supply as well as the device itself.

11.3 Basic Settings

To remove the factory settings, please make the following adjustments:

Pressure Unit:

Select the desired pressure unit by pressing the button **“Unit”** in the main menu via touchscreen (⇒ chapter 11.4.1).

Operating Language:

In the set up menu → **“Display”** → **“Language”** (⇒ chapter 11.4.2), the required operating language can be selected.

11.4 Menu Navigation and Buttons

11.4.1 Main Menu



Fig. 11.4.1-1

The main menu is the main screen of the device and appears right after the device is switched on. Here, you can read the **actual pressure** and the **set (reference) pressure** and you can make the main settings by using the buttons. **Active buttons** are always highlighted **green**. The activation is done via touchscreen. The following buttons and values can be operated or displayed in the main menu:

Tare:

The displayed actual pressure value can be saved as tare. By pressing this button, the actual pressure value is defined as **“zero pressure”**.



CAUTION! The device might be damaged due to overpressure. Please bear in mind that the actual pressure is not released when set to zero, but is still within the device. During control, this value is further increased by the set reference value.

Absolute Pressure:

By activating the **“ABS”** function, the pressure range is switched from gauge pressure to absolute pressure (this setting is only available if a barometer is integrated). The **“Tare”** button is locked or not available in the absolute pressure mode.

Vent:

By pressing this button, you vent the device.

Control:

By pressing this button, you start the control process. Here, the actual pressure is equalised to the specified reference pressure. The control rate is depending on the selected control mode and the volume to be regulated.

Unit:

By pressing this button, you access another menu that will enable you to select the required pressure unit via the according button. Via touchscreen, you can choose between 15 different units.

Set Up:

By pressing this button, you access the set up menu. There you can adjust more precise parameters for the control process. For further information, please refer to chapter 11.4.2.

Pressure Range (Single Range Device):

The button with the pressure range (e.g. 0 – 2 bar) represents a sensor with a defined pressure interval. The actual pressure changes accordingly within this range if a button, and therefore the associated pressure sensor, was selected manually.

Pressure Ranges (Multiple Range Device):

Additional buttons with different pressure ranges represent further sensors with their respective pressure intervals. The actual pressure changes accordingly within this range if a button, and therefore the associated pressure sensor, was selected manually.

AUTO:

If this button is activated (highlighted in green), the device automatically chooses the ideal pressure range.

Actual Pressure:

This value indicates the controlled actual value in the selected pressure unit (e.g. bar) and cannot be modified manually. As soon as the actual value is equal to the reference value within a specified tolerance, this value is highlighted in green.

dP:

The control deviation of the actual pressure from the reference pressure is displayed above the actual pressure. The permissible control deviation is set by the three modes **Fast**, **Normal** and **Precision**.

Set:

This button displays the reference pressure. This reference pressure can also be modified here by pressing the displayed value. Then a new screen appears:



Fig. 11.4.1-2

Operating Instructions

Precision Pressure Controller/Calibrator DPC 3800 HD

Enter the desired reference pressure via the **numerical keypad**. Previous entries can be deleted with **"CLR"** or the cursor key. Confirm with **"OK"**. Press **"ESC"** if you choose not to save the changes. If the entered value flashes red and is not accepted, the permissible reference value range might be exceeded.

Step:

This button displays the interval or the value, by which the reference pressure can be gradually increased or decreased. This value can be changed by pressing the step button. Now enter the required interval via the numerical keypad.

+/-:

With these buttons you can gradually increase (+) or decrease (-) the reference pressure. Here, the interval is defined via the field **"Step"**.

11.4.2 Set Up Menu

In the set up menu, you can adjust the decimal places of the pressure readings, of the control tolerance and of the vacuum valve for a vacuum pump (optional) as well as further settings for an external operation. You may enter the set up menu by pressing the button **"Set Up"** on the touchscreen both in the main menu and in the submenus of the set up menu. The following screen appears:

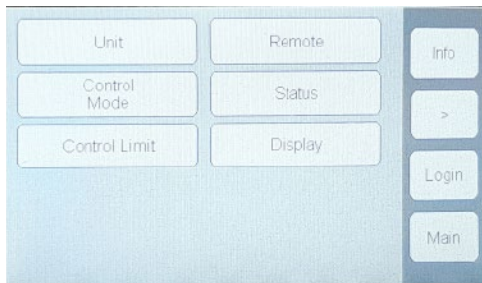

Fig. 11.4.2-1

Info:

By pressing this button, the serial number and the BIOS version of the device is displayed.

Login:

By pressing this button, you can log on to the service menu (⇒ chapter 11.7).

Main:

By pressing the button **"Main"**, you return to the main menu.

Control Mode:

The three options **Fast**, **Normal** and **Precision** can be accessed via the button **"Control Mode"**. The selected mode is highlighted in green.

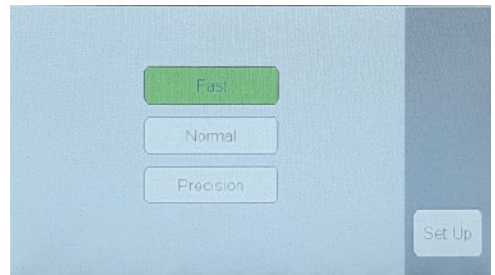

Fig. 11.4.2-2

Control Limit:

The **"Control Limit"** indicates from which maximum pressure onwards the safety ventilation shall be activated. This safety ventilation aims to **protect the test item**. This value can be set by touching the field **"Control Limit"** and entering the required value via numerical keypad. If you want to tap the full potential of a pressure sensor, entering a value slightly above the limit of the pressure sensor is recommended.

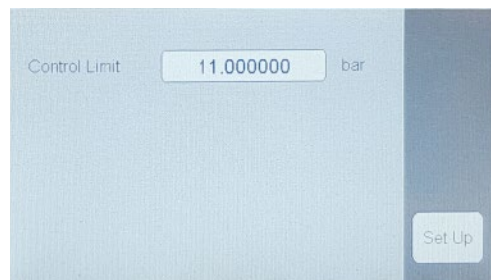

Fig. 11.4.2-3

Remote:

If an external computer is connected, a command is displayed after pressing this button, which was issued by the external computer prior to this:

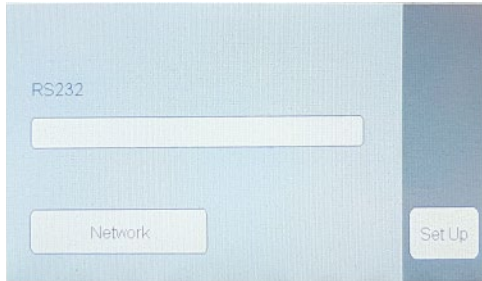

Fig. 11.4.2-4

Network:

Via the menus "Set Up" and "Remote" you access the screen "Network". By pressing this button, you access the network menu, where you can establish the connection of an external computer. There you have the option to enter **IP address**, **subnet** and **gateway** by touching the respective fields:

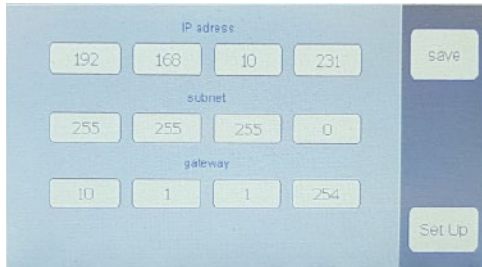

Fig. 11.4.2-5

Please confirm your entries with "save". For detailed information on the external operation, please refer to chapter 11.6.

Display:

By pressing the button "Display", you access the menu, where you can adjust the screen brightness. The percentage changes are made via the "+"/"-" buttons. In this menu you will also find the button "Language" for the selection of the desired operating language as well as the button "Units res." for the adjustment of the desired decimal places of the units:

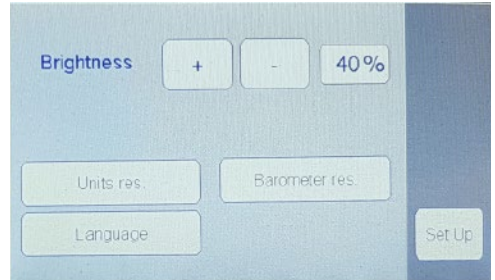

Fig. 11.4.2-6

Language:

Up to now, the languages **German**, **English**, **Russian** and **Italian** are available as operating language. New languages are added constantly and can be accessed via the button "Language". The button of the selected language is highlighted in green.

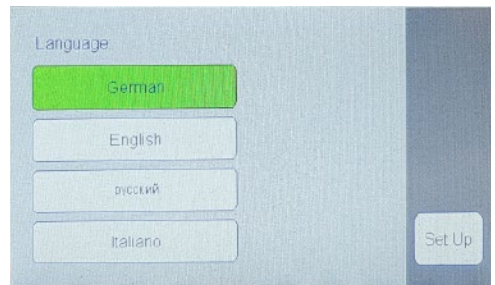

Fig. 11.4.2-7

Units Resolution:

With this button, you define the decimal places of the respective pressure units depending on the selected control mode:

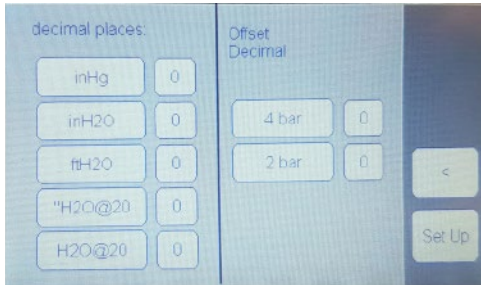

Fig. 11.4.2-8

Select the desired unit, for which you want to change the decimal places, via touchscreen. A numerical keypad appears, where you can enter the desired number of decimal places.

11.5 Control

The core function of this device is the pressure regulation and calibration of pressure measuring instruments. Please regard the following directions for successful control:

- Connect a sufficient pressure supply to the connection **"Supply"**.
- Connect a test item if necessary.
- Switch on the device. The **main menu** appears (⇒ fig. 11.5):

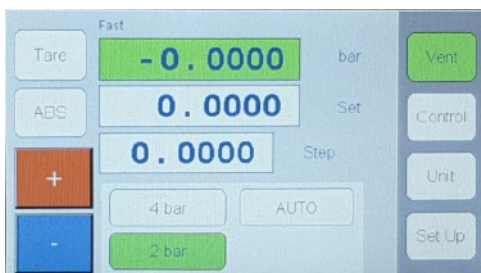

Fig. 11.5

- Enter the desired pressure unit via **main menu** → **"Unit"**.
- If necessary, enter the decimal places (**units**), the **control tolerance** as well as the **control limit** via the **set up menu**.
- Enter the **set value** in the **main menu**.
- Enter the step interval via the field **"Step"**.
- Afterwards, press the button **"Control"**. The actual pressure will now be adjusted to the specified reference pressure.
- If applicable, please pay attention whether the test item indicates the settled actual or reference pressure correctly.
- Press the **"+"** or the **"-"** button to increase or decrease the reference value gradually.
- When you finished the control process, you can manually exhaust the pressure from the device by pressing the button **"Vent"** in the **main menu**.



If the actual pressure exceeds the previously set control limit, the safety ventilation will be initiated automatically to protect the test item.



CAUTION! The device may be damaged by overpressurisation. Therefore, please follow the direction on the button **"Tare"** in chapter 11.4.1.

11.6 External Operation

You have the following options if you want to control the device externally:

Ethernet Interface:

The Ethernet communication port enables the device to communicate with a computer via 10/100 Base-T-Specifications. The Ethernet communication is transmitted via RJ-45 standard cable.

Prior to the first use, the parameters **IP address**, **subnet** and **gateway** must be set. Access the **set up menu** via the **main menu** and press the button **"Network"**.



Please consult your network administrator before connecting the device with your network to avoid conflicts with existing IP addresses.

RS-232 Interface:

When using the RS-232 interface, a cable must be connected directly from the instrument to a suitable port on the computer ('point to point' link). The device is configured as data terminal equipment (DTE).

IEEE-488.2 Interface (Optional):

The connection of the IEEE-488.2 interface is designed as a 24-pin IEEE-488 socket. The manufacturer of the IEEE-488 interface board provides software to allow communication between the DPC 3800 HD and various programming languages. Usually also an interactive troubleshooting programme is provided. For further details on this, please read the documentation of the board manufacturer.

Software (Optional):

Besides the optionally available calibration software DynaCal, which allows for comfortable calibration of pressure measuring instruments, including automatic creation of test certificates, the user is able to create own software programmes as well (e.g. via LabVIEW).



Please select the button "Remote" via the set up menu to read the external commands from your connected computer on the device (⇒ chapter 11.4.2).

11.7 Service Menu

In the **set up menu** (⇒ chapter 11.4.2) under "Login", you can log on to the protected service section of the device. There, basic settings, maintenances and fine adjustments can be made.



CAUTION! Unauthorised modifications in the service menu may result in considerable functional limitations of the device. Therefore, all settings in this section shall be made by trained and qualified personnel only.

If you enter the service number **48485** in the login section, you access the following service menu (⇒ fig. 11.7-1):

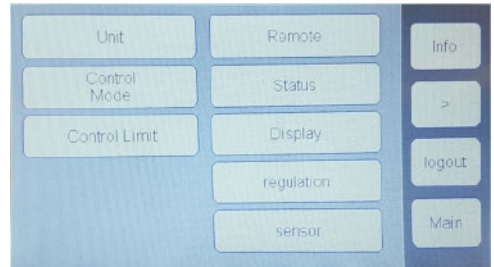

Fig. 11.7-1

Additionally to the freely accessible parameter settings, you can make protected settings there as well.

Regulation:

By pressing this button, you access another menu (⇒ fig. 11.7-2):

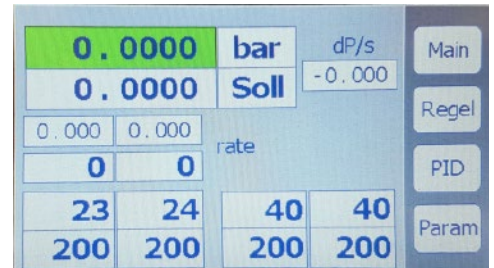

Fig. 11.7-2

In the lower part of the screen, you can read the respective pulse widths. The left side represents the pressure generation, whereas the right side represents the pressure reduction.



Please enter this menu and contact our sales team if you have problems with your device. In case of uncertainties, do not make any arbitrary adjustments.

By pressing the buttons “Main” and “Set Up”, you return to the main and set up menu respectively.

The button “Control” starts the control process. By pressing the button “PID”, you access the following submenu (⇒ fig. 11.7-3):



Fig. 11.7-3

By pressing the button “Stable”, you can define whether the deviation (dP) of the actual pressure is displayed **above the actual value field** (“Stable” switched on) or **within the actual value field** (“Stable” switched off) in the main menu.

Sensor:

By pressing the button “sensor”, the following menu appears (⇒ fig. 11.7-4):

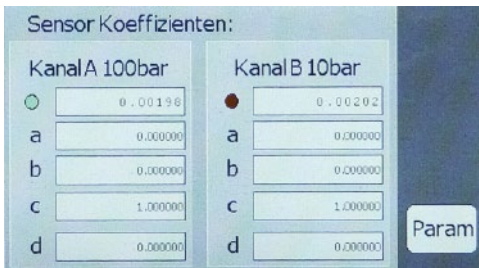

Fig. 11.7-4

This signal display shall only be accessed for checking the sensors. The fields concerning the recalibration should not be modified arbitrarily by the operator.

12. Maintenance



CAUTION! Material damage and loss of warranty!

Any modifications or interventions in the device, made by the customer, might damage important parts or components. Such intervention leads to the loss of any warranty and manufacturer’s responsibility!
→ Never modify the device or perform any repairs yourself.

Have your device maintained regularly to ensure proper function of the instrument. For this purpose, please contact authorised service partners or contact ARMATURENBAU GmbH or MANOTHERM Beierfeld GmbH directly. Manufacturers and service partners offer you the expertise and the qualifications necessary for proper maintenance of your instrument with appropriate special tools.

In order to avoid a loss of functionality, we recommend the following intervals:

- Recalibration of the measuring equipment at an interval of 1 year
- Maintenance of the mechanical components incl. cleaning and the replacement of the backup battery at an interval of 2 years

13. Dismounting and Disposal



WARNING! Risk of injury!

Never remove the device from a system in operation.
Make sure that the system is switched off professionally.

Work on electrical or pneumatic/hydraulic equipment must be carried out by qualified and authorised technical staff only, observing the corresponding safety regulations and according to the operating instruction.

Before dismounting:

Check before dismounting, whether the system

- is switched off,
- is in a safe and currentless state,
- is unpressurised and cooled down.

Dismounting:

- Make sure that there is no positive or negative overpressure on the device and that all components are at room temperature.
- Switch off the device by pressing the main switch on the right of the front side of the device.
- First, pull out the mains cable from the power socket and then from the mains input socket of the device.
- Remove the pressure connections.
When removing the outer pressure connection, make sure that the connections on and in the device are not overtightened or loosened.
- Remove the device if necessary.
- Make sure that the device is free of any medium.
- Protect the connections with the supplied protective caps.

Disposal:

Prior to disposal of the device, all adhering medium residues have to be removed. This is especially important if the medium is health-damaging, e.g. corrosive, toxic, carcinogenic or radioactive.

In compliance with the directives 2011/65/EU (RoHS) and 2012/19/EU (WEEE), the device must be disposed separately as electrical and electronic waste. Please regard legal regulations of the country of distribution.



NO DOMESTIC WASTE!

The instrument comprises various materials. It shall not be disposed together with domestic waste.

- Bring the instrument to your local recycling plant

or

- send the the instrument back to your supplier or to the ARMATURENBAU GmbH or MANOTHERM Beierfeld GmbH.

14. CE Conformity



The CE marking of the instruments certifies the conformity with prevailing EU directives for placing products on the market within the European Community.
The corresponding declaration of conformity is part of this manual (⇒ chapter 18 "Declaration of Conformity").

Operating Instructions

Precision Pressure Controller/Calibrator DPC 3800 HD

15. Common Units and their Conversion Factors

ID	Name	Abbreviation	p [bar]/p [Unit]	p [Unit]/p [bar]
0	Bar	bar	1.000000E+00	1.000000E+00
1	Millibar	mbar	1.000000E+03	1.000000E+03
2	Pascal	Pa	1.000000E-05	1.000000E+05
3	Pound-force/inch ²	psi	6.894757E-02	1.450377E+01
4	Standard atmosphere (760 Torr)	atm	1.013250E+00	9.869233E-01
5	Technical atmosphere	kp/cm ²	9.806650E-01	1.019716E+00
6	Pound-force/foot ²	lbf/ft ²	4.788026E-04	2.088543E+03
7	Kilopond/cm ²	kp/cm ²	9.806650E-01	1.019716E+00
8	Centimetre of water 4 °C	cmWS (4 °C)	9.806380E-04	1.019744E+03
9	Inch of water 4 °C	inH ₂ O (4 °C)	2.490820E-03	4.014742E+02
10	Inch of water 60 °F	in H ₂ O (60 °F)	2.488400E-03	4.018647E+02
11	Foot of water 4 °C	ft H ₂ O (4 °C)	2.988980E-02	3.345623E+01
12	Micrometre of mercury 0 °C (Micron)	µmHg (0 °C)	1.333224E-06	7.500615E+05
13	Millimetre of mercury 0 °C (Torr)	mmHg (0 °C)	1.333224E-03	7.500615E+02
14	Centimetre of mercury 0 °C	cmHg (0 °C)	1.333224E-02	7.500615E+01
15	Inch of mercury 0 °C	inHg (0 °C)	3.386380E-02	2.953006E+01
16	Inch of mercury 60 °F	inHg (60 °F)	3.376850E-02	2.961340E+01

16. Troubleshooting Measures

If faults cannot be cleared with the help of the operating instructions, the device must be decommissioned instantly, it must be ensured that no pressure is applied anymore, and it must be secured against unintentional startups. Following this, the information has to be given to a superior and to authorised service personnel. Repairs shall only be carried out by the manufacturer. Any modifications or changes by the operator to the device are not permissible. Work on electrical or pneumatic/hydraulic equipment must be carried out by qualified and authorised technical staff only, observing the corresponding safety regulations.

In case of faults caused by defects of the electrical or pneumatic/hydraulic equipment, the operators must inform their superiors immediately and consult qualified and authorised technical staff for maintenance.

16.1 Description of Faults and Measures

If the fuses of the mains input socket have to be replaced, only suitable 2 Ampere fuses type T2L250V shall be used.

Description of Faults	Measures
When switching on the device, no measuring value(s) appear(s) after 10 seconds, but the entire screen remains white or dark.	Turn off the device, wait about 5 seconds, and turn it on again.
The screen is dark and the measures for faults of type I are without effect.	Check, whether the mains cable is connected properly. Have also authorised technical staff check whether the supply voltage is correct.
The screen is dark and the measures for faults of type II are without effect.	First, pull out the mains cable from the power socket and then from the mains input socket of the device. After that, pull out the fuse holder and check the fuses.
Malfunction during operation.	Turn off the device, wait 5 seconds, and turn it on again.
Unstable control.	Check the piping for leakages.
Intensified release of medium at the Supply port during pressure controlling.	Turn off the device, wait about 5 seconds, and turn it on again. (Controller will be reinitialised.)
The reference value is not reached.	Check, whether the supply pressure at the Supply port is at the required level (⇒ chapter 7 "Technical Data") and check the piping for leakages, or check the setting of " control limit " in the control tolerance menu: controlled system recognition.

Operating Instructions

Precision Pressure Controller/Calibrator DPC 3800 HD

17. Annex

17.1 DPC Commands

Command	Usage	Description
?	? <CR><LF>	General query command. The answer string will be according to the active output format set with N0 e.g. instrument set N0 will send actual value; desired value; stable status.
N[Wert]	N0 ... N99 <CR><LF>	Changes the output format. Please refer to the specification of the N command. For optional additions values from 0 to 99 are possible but will cause the answer strings to be the same than N0
N?	N? <CR><LF>	Query the output format that is currently active
P=[WERT]	P=5.05 <CR><LF>	Will set the desired value to 5.05 in current unit
R0 R1 R2 R3	R1<CR><LF>	Changes the active range. R0 ⇔ auto range ! The instrument has to be in vent mode!
T0	T0<CR><LF>	Tare off. Only in vent mode
T1	T1<CR><LF>	Will tare (zero) all pressure ranges. ! The instrument has to be in vent mode!
V0	V0<CR><LF>	Open the vent valve
V1	V1<CR><LF>	Close the vent valve
C0	C0<CR><LF>	Pressure controller off
C1	C1<CR><LF>	Pressure controller on. The instrument will control to the desired value set with P=command
#T16	#T16<CR><LF>	! Only for compatibility reasons! Will send an actual pressure value
U	U1 ... U24<CR><LF>	Changes the pressure unit according to entered unit ID
U?	U?<CR><LF>	Query active pressure unit. The controller will send the unit ID number
DB=[WERT]	DB=0.01<CR><LF>	Set dead band of first range
DB1=[WERT]	DB1=0.01<CR><LF>	Set dead band of active range
DB2=[WERT]	DB2=0.01<CR><LF>	Set dead band of second range
DB3=[WERT]	DB3=0.01<CR><LF>	Set dead band of third range
DB?	DB?<CR><LF>	Query dead band of active range
DB1?	DB1?<CR><LF>	Query dead band of first range
DB2?	DB2?<CR><LF>	Query dead band of second range
DB3?	DB3?<CR><LF>	Query dead band of third range
LOCK1	LOCK1<CR><LF>	Lock touchscreen
LOCK0	LOCK0<CR><LF>	Unlock touchscreen
LIMU=[WERT]	LIMU=22.2<CR><LF>	Set upper limit
LIMU?	LIMU=22.2<CR><LF>	Query upper limit
ABS1	ABS1<CR><LF>	Change to absolute mode ! BaroRef has to be installed!
ABS0	ABS0<CR><LF>	Change to gauge mode ! BaroRef has to be installed!
ABS?	ABS?<CR><LF>	Query pressure mode; if -1, no barometer installed
DIG=	DIG=1<CR><LF>	Set decimal places (0...5)
DIG?	DIG?<CR><LF>	Query decimal places
ID?	D?<CR><LF>	Send the system ID and configuration Output format: SN;Range 1;Range 2;Range 3;BaroRef;Options

OPT?	OPT?<CR><LF>	List the installed options. Output format: option 1; option 2; option 3; option 4 e.g.: O1;False;False;False<CR><LF>
PIDIN=	PIDIN=P;I;D;C<CR><LF>	Change the PID setting for the inlet valve. ! Caution, this command will change the control behaviour of the instrument. Write down the factory values from the regulation menu!
PIDOUT=	PIDOUT=P;I;D;C<CR><LF>	Change the PID setting for the outlet valve. ! Caution, this command will change the control behaviour of the instrument. Write down the factory values from the regulation menu!
LANG=	LANG=1<CR><LF>	Changes the menu language: 1 = German 2 = English 3 = Russian 4 = Italian
LANG?	LANG?<CR><LF>	Query the active language
CONTROL0		This command will set the controller to Vent
CONTROL1		This command will set the controller to Regulation
CONTROL2		This command will set the controller to Measure
CONTROL?		Gives the current mode back, i.e. CONTROL2 if the regulator is active
CONTROLMODE=	CONTROLMODE=FAST CONTROLMODE=NORMAL CONTROLMODE=PRECISE CONTROLMODE=CUSTOM	This command will set the controller into Fast Mode This command will set the controller into Normal Mode This command will set the controller into Precise Mode This command will set the controller into Custom Mode
CONTROLMODE=?		This command will send the active mode back, i.e. If the controller is in Precise Mode the controller will send CONTROLMODE=PRECISE

Operating Instructions

Precision Pressure Controller/Calibrator DPC 3800 HD

DPC 3800 Remote Communication Example 1:

Available output formats for the **N[value] command**
Possible values for output are N0 ... N99, if no other output format is available, the instrument will use the N0 Format when “?<CR><LF>” is sent.

ACTUAL VALUE; DESIRED VALUE; STABLE
<CR><LF>

If the output format is set to N10. The DPC 3800 will send the following after sending:

Send: ?<CR><LF>

Answer string:

ACTUAL_VALUE; DESIRED_VALUE; STABLE_STA-
TUS; STABLE_TIME; DEAD_BAND; CONTROL_ON/
OFF; VENT_OPEN/CLOSED; ABS_REL; TARE_AN/
AUS; AKTIVE_PRESSURERANGE; PRESSURE_
UNIT; BAROREF; OVERPESSURE_SHUTOFF;
DRIVER_STATUS <CR><LF>

Description:

1. **ACTUAL_VALUE:**
Pressure Value in the active pressure unit.
2. **DESIRED_VALUE:**
Pressure point set with the P=[value] com-
mand in active unit.
3. **STABLE_STATUS:**
When the stable criteria defined with DEAD_
BAND is reached, STABLE_STATUS is 1 oth-
erwise 0.
4. **STABLE_TIME:**
Elapsed time (in ms) since the controller
reached DEAD_BAND criteria (STABLE_STA-
TUS=1). After 60,000 ms (1 minute), the time
starts from zero again.
5. **DEAD_BAND:**
Window [\pm value in bar] around the set value in
which the set pressure point is reached close
enough to take a reading.
6. **CONTROL_ON/OFF:**
If 1, then the controller is active, 0 if the control-
ler is turned off.

7. **VENT_OPEN/CLOSED:**
If 1, then the pressure system is open to envi-
ronment, 0 closed.
8. **ABSOLUT_GAUGE:**
1 for absolute pressure mode, 0 for gauge
pressure mode.
9. **TARE_ON/OFF:**
When vented, all sensors in gauge mode are
set to zero.
10. **AKTIVE_PRESSURERANGE:**
0 for Auto, 1 highest, 2 middle, 3 lowest pres-
sure range.
11. **PRESSURE_UNIT:**
Pressure unit ID number.
12. **BAROREF:**
Pressure reading of the barometric reference
in active unit. If no barometer is installed, the
value will be -1.
13. **OVERPESSURE_SHUTOFF:**
Pressure value in bar when the controller will
vent for protection.
14. **DRIVER_STATUS:**
Byte value indicating the 24V driver status.

DPC 3800 Remote Communication Example 2:

If the output format is set to N11. The DPC 3800 will send the following after sending:

?<CR><LF>

ACTUAL_VALUE; DESIRED_VALUE; STABLE_STATUS; STABLE_TIME; DEAD_BAND; REGLER_AUS; VENT_OPEN/CLOSED; ABS_REL; TARE_ON/OFF; AKTIVE_PRESSURERANGE; RESSURE_UNIT; BAROREF; OVERPESSURE_SHUTOFF; DRIVER_STATUS; PRESSURE_RATE<CR><LF>

Description:

1. **ACTUAL_VALUE:**
Pressure Value in the active pressure unit.
2. **DESIRED_VALUE:**
Pressure point set with the P=[value] command in active unit.
3. **STABLE_STATUS:**
When the stable criteria defined with DEAD_BAND is reached, STABLE_STATUS is 1 otherwise 0.
4. **STABLE_TIME:**
Elapsed time (in ms) since the controller reached DEAD_BAND criteria (STABLE_STATUS=1). After 60,000 ms (1 minute), the time starts from zero again.
5. **DEAD_BAND:**
Window [\pm value in bar] around the set value in which the set pressure point is reached close enough to take a reading.
6. **CONTROL_ON/OFF:**
If 1, then the controller is active, 0 if the controller is turned off.
7. **VENT_OPEN/CLOSED:**
If 1, then the pressure system is open to environment, 0 closed.
8. **ABSOLUT_GAUGE:**
1 for absolute pressure mode, 0 for gauge pressure mode.
9. **TARE_ON/OFF:**
When vented, all sensors in gauge mode are set to zero.
10. **AKTIVE_PRESSURERANGE:**
0 for Auto, 1 highest, 2 middle, 3 lowest pressure range.
11. **PRESSURE_UNIT:**
Pressure unit ID number.
12. **BAROREF:**
Pressure reading of the barometric reference in active unit. If no barometer is installed, the value will be -1.
13. **OVERPESSURE_SHUTOFF:**
Pressure value in bar when the controller will vent for protection.
14. **DRIVER_STATUS:**
Byte value indicating the 24V driver status.
15. **PRESSURE_RATE:**
Pressure change rate.

Operating Instructions Precision Pressure Controller/Calibrator DPC 3800 HD

18. Declaration of Conformity

EU-Konformitätserklärung

EU Declaration of Conformity

nach DIN EN ISO / IEC 17 050-1
according to DIN EN ISO / IEC 17 050-1



Für die nachfolgend bezeichneten Erzeugnisse

Digitales Präzisions-Druckmessgerät

Typen **DPG 3600, DPG 3600 HD**

Präzisions-Druckkalibrator

Typen **DPC 3800, DPC 3800HD, DPC 3800 HDG**

wird hiermit erklärt, dass sie den wesentlichen Schutzanforderungen entsprechen, die in nachfolgend bezeichneten Richtlinien festgelegt sind:

We hereby declare for the following named goods

Digital Precision Pressure Indicator

Models **DPG 3600, DPG 3600 HD**

Precision Pressure Controller

Models **DPC 3800, DPC 3800HD, DPC 3800 HDG**

that they meet essential protective requirements which have been fixed in the following directives:

RICHTLINIE 2014/30/EU DES EUROPÄISCHEN PARLAMENTS UND DES RATES vom 26. Februar 2014 zur Angleichung der Rechtsvorschriften der Mitgliedstaaten über die elektromagnetische Verträglichkeit – kurz: EMV-Richtlinie	DIRECTIVE 2014/30/EU OF THE EUROPEAN PARLIAMENT AND THE COUNCIL from 26. February 2014 on the approximation of the laws of the Member States concerning the electromagnetic compatibility – short: EMC Directive
RICHTLINIE 2014/35/EU DES EUROPÄISCHEN PARLAMENTS UND DES RATES vom 26. Februar 2014 zur Angleichung der Rechtsvorschriften der Mitgliedstaaten betreffend elektrische Betriebsmittel zur Verwendung innerhalb bestimmter Spannungsgrenzen – kurz: Niederspannungsrichtlinie	DIRECTIVE 2014/35/EU OF THE EUROPEAN PARLIAMENT AND THE COUNCIL from 26. February 2014 on the approximation of the laws of the Member States concerning electrical equipment designed for use within certain voltage limits – short: Low Voltage Directive
RICHTLINIE 2014/68/EU DES EUROPÄISCHEN PARLAMENTS UND DES RATES vom 15. Mai 2014 zur Angleichung der Rechtsvorschriften der Mitgliedstaaten über Druckgeräte – kurz: Druckgeräte richtlinie	DIRECTIVE 2014/68/EU OF THE EUROPEAN PARLIAMENT AND THE COUNCIL from 15. May 2014 on the approximation of the laws of the Member States concerning pressure equipment – short: Pressure Equipment Directive
RICHTLINIE 2011/65/EU DES EUROPÄISCHEN PARLAMENTS UND DES RATES vom 8. Juni 2011 zur Beschränkung der Verwendung bestimmter gefährlicher Stoffe in Elektro- und Elektronikgeräten – kurz: RoHS-Richtlinie	DIRECTIVE 2011/65/EU OF THE EUROPEAN PARLIAMENT AND OF THE COUNCIL of 8 June 2011 on the restriction of the use of certain hazardous substances in electrical and electronic equipment – short: RoHS-Directive

Dokumentationsverantwortlicher
im Sinne der Richtlinien:

Executive person for documentation
in the sense of the directives

Name, Vorname: Name, first name:	Hendrik Schumacher
Stellung im Betrieb des Herstellers: Position in the factory:	Leitung Konstruktion Constructional Management

Zur Beurteilung des Erzeugnisses hinsichtlich der Richtlinien wurden folgende Normen herangezogen:

The following standards have been used to assess the good regarding the directives:

Norm Standard:	Richtlinienbezug Reference to directive
EN 61326-1: 2013-07	EMV-Richtlinie 2014/30/EU EMC Directive 2014/30/EU
EN 61010-1: 2011-07	Niederspannungsrichtlinie 2014/35/EU Low Voltage Directive 2014/35/EU
AD 2000 Regelwerk	Druckgeräte richtlinie 2014/68/EU Pressure Equipment Directive 2014/68/EU
DIN EN 50581:2013-02	RoHS-Richtlinie 2011/65/EU RoHS-Directive 2011/65/EU

Diese Erklärung gilt für alle nach Datenblätter 10261,10262, 10461, 10462 und 10463 hergestellten Exemplare.

This declaration is valid for all instruments manufactured acc. to data sheets 10261, 10262, 10461, 10462 and 10463.

Diese Erklärung wird verantwortlich für die Hersteller:

This declaration is responsibility given for the manufacturers:

ARMATURENBAU GmbH
MANOTHERM Beierfeld GmbH

abgegeben durch/by

Bernd Vetter

Geschäftsführer/ Managing Director

WESEL 2018-04-16
Ort/ Location Datum/ Date

rechtsgültige Unterschrift/ Legal signature

098-ELL-Konformitätserklärung DPG, DPC, Ausg. 04/18
ARMATURENBAU GmbH · Manometerstraße 5 · D – 46487 Wesel-Ginderich · Tel.: +49 2803 9130 – 0 · Fax: +49 2803 1035 · mail@armaturenbau.com · www.armaturenbau.de
MANOTHERM Beierfeld GmbH · Am Gewerbehof 9 · D – 08344 Grünhain-Beierfeld · Tel.: +49 3774 58 – 0 · Fax: +49 3774 58 – 545 · mail@manotherm.com · www.manotherm.de

Operating Instructions

Precision Pressure Controller/Calibrator DPC 3800 HD

Operating Instructions
Precision Pressure Controller/Calibrator DPC 3800 HD



Sales and Export South, West, North
ARMATURENBAU GmbH
Manometerstraße 5
D – 46487 Wesel-Ginderich
Tel.: +49 2803 9130 – 0
Fax: +49 2803 1035
mail@armaturenbau.com
www.armaturenbau.com

Subsidiary Company, Sales and Export East
MANOTHERM Beierfeld GmbH
Am Gewerbepark 9
D – 08344 Grünhain-Beierfeld
Tel.: +49 3774 58 – 0
Fax: +49 3774 58 – 545
mail@manotherm.com
www.manotherm.com