



Contents

| | |
|--|----|
| 1. Information on This Operating Instruction | 1 |
| 1.1 Pictographs Used | 2 |
| 1.2 Exclusion of Liability | 2 |
| 2. Safety Instructions | 2 |
| 3. Device Description | 3 |
| 3.1 Intended Use | 4 |
| 4. Technical Data | 4 |
| 5. Preparation, Functions and Measuring Process | 5 |
| 6. Maintenance / Cleaning, Storage and Transport | 7 |
| 7. Dismounting and Disposal | 7 |
| 8. Declaration of Manufacturer | 10 |

1. Information on This Operating Instruction

- The manual is aimed at specialists and semi-skilled personnel.
- Please read the instructions carefully before carrying out any operation and keep the specified order.
- Thoroughly read and understand the information in chapter 2 "Safety Instructions".

If you have any problems or questions, please contact your supplier or contact us directly at:

ARMANO

ARMANO Messtechnik GmbH

Location Beierfeld

Am Gewerbepark 9 • 08344 Grünhain-Beierfeld

Tel.: +49 3774 58 – 0 • Fax: +49 3774 58 – 545

mail@armano-beierfeld.com

Location Wesel

Manometerstraße 5 • 46487 Wesel-Ginderich

Tel.: +49 2803 9130 – 0 • Fax: +49 2803 1035

mail@armano-wesel.com

Operating Instructions

Dead Weight Tester PD 1

1.1 Pictographs Used

In this manual, pictographs are used as hazard warnings.

Particular information, instructions and restrictions designed for the prevention of personal or substantial property damage:



WARNING! Is used to warn you against an imminent danger that may result in personal injury or death.

IMPORTANT! Is used to warn you against a possibly hazardous situation that may result in personal, property or environmental damage.

CAUTION! Is used to draw your attention to important recommendations to be observed. Disregarding them may result in property damage.



Passages in the text containing **explanations, information or advice** are highlighted with this pictograph.



The following symbol highlights **actions** you have to conduct or **instructions** that have to be strictly observed.

1.2 Exclusion of Liability

We accept no liability for any damage or malfunction resulting from incorrect installation, inappropriate use of the device or failure to follow the instructions in this manual.

2. Safety Instructions

Please read this operating instruction thoroughly before operating the dead weight tester.

Disregarding the containing warnings, especially the safety instructions, may result in danger for people, the environment, and the device and the system it is connected to.

The dead weight tester corresponds with the state of engineering at the time of printing. This concerns the accuracy, the operating mode and the safe operation of the device.

In order to guarantee that the device operates safely, the operator must act competently and be conscious of safety issues.

The ARMANO Messtechnik GmbH provides support for the use of its products either personally or via relevant literature. The customer verifies that our product is fit for purpose based on our technical information. The customer performs customer and application specific tests to ensure that the product is suitable for the intended use. With this verification, all hazards and risks are transferred to our customers. Our warranty expires in case of inappropriate use.

Qualified personnel:

The personnel that is charged for the installation, operation and maintenance of the dead weight tester must hold a relevant qualification. This can be based on training or relevant tuition. The personnel must be aware of this manual and have access to it at all times.

General safety instructions:

- In all work, the existing national regulations for accident prevention and safety at the workplace must be complied with. Any internal regulations of the operator must also be complied with, even if these are not mentioned in this manual.
- Use the dead weight tester in its perfect technical condition only. Damaged or defective instruments need to be checked immediately and replaced if necessary.
- Only use appropriate tools for mounting, connecting and dismantling the dead weight tester.
- Nameplates or other information on the device shall neither be removed nor obliterated, since otherwise any warranty and manufacturer responsibility expires.

Special safety instructions:

Warnings, which are specifically relevant to individual operating procedures or activities, are to be found at the beginning of the relevant sections of this operating instruction.

Operating Instructions

Dead Weight Tester PD 1

3. Device Description

Dead weight testers are high-precision mechanical measuring instruments that are suitable for testing, adjusting and calibrating pressure measuring instruments without using an external reference device.

The main components are measuring system, valve units, pressure generation, adjusting mechanism for fine adjustment and set of weights.

The measuring system consists of a fine lapped piston / cylinder pair. The weight-loaded piston is pressed down by the local gravitation of the weights. The test pressure, which is generated and adjusted by either an electric pump, or an integrated metal bellows, or externally via the admission pressure connection, acts from below towards the piston surface area.

This test pressure is increased until the pneumatic force of the medium (usually air) on the piston surface area (acting from below) compensates the weight force of the piston / weight system and the equilibrium of forces is reached. During this state of equilibrium, the piston floats freely in the cylinder.

In order to simplify the handling, the weights are already standardised to the specific determined piston surface area and the local gravitation at the installation site. The set of weights is available discretely graduated in different pressure units (bar, Pa, psi).

Piston and weights are set in rotation by manual initiation and kept floating in order to minimise the influence of static friction between piston and cylinder and therefore to guarantee a sensitive discrimination threshold.

The dead weight tester described herein operates in a range from 0.03 to 1 bar.

Components:

- ① Measuring system
- ② Reading device
- ③ Stop valve "Admission pressure / Vordruck"
- ④ Stop valve "Test connection / Prüfanschluss"
- ⑤ Stop valve "Measuring system / Messsystem"
- ⑥ Stop valve "Ventilation / Entlüftung"
- ⑦ Mechanical admission pressure indication
- ⑧ "Adjusting mechanism / Nachstelleinrichtung"
- ⑨ Position indication adjusting mechanism
- ⑩ Push button "Pump / Pumpe"
- ⑫ Test connection
- ⑬ Adjustable feet

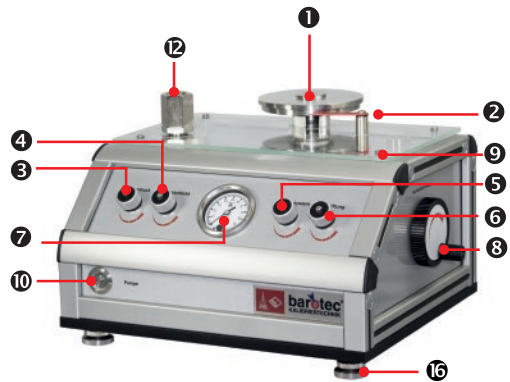

Nameplate and label:

The nameplate is placed on the back of the dead weight tester. It contains the most important technical data and information.

Scope of delivery:

The delivery includes – in addition to the dead weight tester and the set of weights:

- 1 operating instruction
- 1 transport case dead weight tester
- 1 transport case set of weights
- 1 special gasket for test item, with 2 encased O-rings
- 1 clamping sleeve G ½ LH / G ½
- 1 adapter for N6x1 (admission pressure connection)
- 1 6 V mains adapter

Operating Instructions

Dead Weight Tester PD 1

3.1 Intended Use

The dead weight tester shall only be used for testing, adjusting and calibrating pressure measuring equipment. Do not use the dead weight tester beyond its specification or contrary to the operating instructions.

The operational safety of the device supplied is only guaranteed by intended use. The specified limit values (⇒ chapter 4 "Technical Data") must not be exceeded. This particularly applies for the adherence to the permissible full scale value and the permissible temperature range.

When using the dead weight testers, a high degree of care and precaution is required. It has to be protected from strong vibrations, moisture, shocks, magnetic fields and static electricity.



IMPORTANT! Risk of injury or material damage due to overpressure!

Exceeding the maximum overload values may lead to material failure of the dead weight tester. This may also cause serious damage to health.

→ Ensure that the overload values are never exceeded.

Please check if the dead weight tester is suitable for your application before ordering and installation.

4. Technical Data

| | |
|---|--|
| Set of weights | in bar / kPa |
| Basic load | 0.03 bar |
| Main measuring range | 0.1 – 1 bar |
| optional admission pressure air | max. 1 bar |
| Reference condition for the guaranteed accuracy | ambient temperature +20 °C ±2 °C (+68 °F ±3.6 °F) |
| Accuracy (factory calibration) | ±0.02 % of the measured value ¹⁾ ±0.05 % of the measured value ¹⁾ |
| Medium | air |
| Nominal piston cross-section | 2 cm ² |
| Rotation of the weights | by manual initiation |
| Standard connection | male G ½ LH with clamping sleeve on G ½ right or M 20x1.5 right, incl. double sealing |
| Connection for external compressed air | plug connection (Prestolock) for PA hose N 4x1 with adapter for N 6x1 |
| Case | aluminum case, grey enamelled (self-supporting cover), 3 adjustable feet for precise horizontal alignment according to integrated circular level |
| Case dimensions (L x W x H) | 300 x 260 x 240 mm (11.81 x 10.24 x 9.45") |

Approx. weight

| | |
|-----------------------------------|------------------|
| Dead weight tester | 15 kg (33.1 lb) |
| Set of weights | 3.1 kg (6.83 lb) |
| Transport case dead weight tester | 2.2 kg (4.85 lb) |
| Transport case set of weights | 2.1 kg (4.63 lb) |

¹⁾ in the main measuring range, the accuracy refers to the measured value; in the secondary measuring range, it refers to 0.1 bar

Operating Instructions

Dead Weight Tester PD 1

5. Preparation, Functions and Measuring Process

If the dead weight tester is not operated under typical laboratory conditions, the installation site should most widely meet the following criteria:

- Kept at constant temperature, without draughts and heat or cold sources
- Dust-free and dry, free from corrosive liquids or vapours
- Vibration-free and low-noise

The work station should be a solid plain table or workbench. Attention should be paid to sufficient free space for operating the dead weight tester.

Transporting the dead weight tester from a cold to a warm environment, condensation may result in an impairment of the device function. Thus, make sure that the device temperature has adjusted to the ambient temperature before commissioning.



IMPORTANT!

When transporting or repositioning, carry the dead weight tester at the case only, never at the measuring system. Otherwise, this may cause serious damage.

Preparation and functions:

The dead weight tester and the set of weights are supplied in separate transport cases.

Place the instrument at the work station and adjust it with the integrated circular level by screwing the adjustable feet in or out. The adjustable feet are equipped with a rubberised lower surface to avoid unintentional sliding.

For using the integrated pump, please connect the mains adapter – the red LED at the push button “Pump / Pumpe” ⑩ indicates operational readiness.

Connection of the admission pressure:

The dead weight tester can either be actuated via external admission pressure or via integrated pump. The connection of the admission pressure is not obligatory for operation.

The “Connection admission pressure / Anschluss Vordruck” ① is either connected via PA hose N4x1 or via adapter for N6x1 to the plug connection ⑦ (Prestolock).

To protect the dead weight tester from contamination, a maintenance unit consisting of pressure regulator and filter (pore size 10–20 µm with oil and water separator) is to be placed into the line of the admission pressure to the dead weight tester. With the pressure regulator, the pressure needs to be limited to max. 1 bar.



IMPORTANT! Limit the admission pressure to a maximum of 1 bar! Otherwise, the device might be damaged. The built-in components, such as the metal bellows of the adjusting mechanism, are designed for an overpressure of maximum 1 bar.

Measuring process:

 All valves have to be closed by turning clockwise.

→ Bring the adjusting mechanism into ⑨ centre position so that the pressure can both be increased and decreased via adjusting mechanism wheel ⑧.

→ Place the double sealing into the clamping sleeve ⑬. The test item is tightly screwed into the clamping sleeve at the test connection ⑫.



IMPORTANT! Attention must be paid to thorough sealing! Please use an appropriate wrench and the designated wrench flat. During screwing in, the pressure measuring devices should never be held at the case!

Test process without connected admission pressure:

 Connect the mains adapter plug – the red LED at the push button “Pump / Pumpe” ⑩ indicates operational readiness.

→ By briefly pushing the push button “Pump / Pumpe” ⑩ you increase the system pressure. You can read the value via built-in pressure gauge ⑦. Press the button until the value of the test pressure is reached approximately.

→ According to the required test pressure, place weights upon the measuring system ① with due regard to the instructions (⇒ “Set of weights”).



IMPORTANT!

Carefully place the weights onto the dead weight tester. All weights need to be applied separately. Never try to place and remove several weights or the entire stack on and from the dead weight tester respectively.

Operating Instructions

Dead Weight Tester PD 1

- Turn the red marking pointer of the reading device **2** towards the measuring system **1** for reading the measuring position. Make sure that the marking pointer does not impede the vertical movement of the measuring system.
- Open the valve "Measuring system / Messsystem" **5**.
- Set the measuring system with the weights into rotation by careful manual initiation and adjust the pressure with the adjusting mechanism **3** so that the centre measuring position is reached. Only if the measuring piston is kept floating, an equilibrium of forces is reached between weight force of the weights and the pneumatic counterforce. The test pressure is adjusted.



Please note!

Keep the time the measuring system rotates at the upper or lower stop as short as possible to avoid increased material wear.

- Open the valve "Test connection / Prüfanschluss" **4** and correct the system pressure with the adjusting mechanism **3** if necessary. Now, the adjusted pressure is applied at the test item.
- Compare the indication value of the test item and, if necessary, note the deviation from the applied actual pressure.



Please note!

The rotation of the measuring system minimises the influence of the static friction between measuring piston and measuring cylinder. Thus, a sensitive discrimination threshold is attained. A rotation of approximately 60 rpm is sufficient. Avoid excessive rotational speeds. Otherwise, the weights might fall down and might possibly damage the glass panel.

Test process with connected admission pressure:

Connecting the mains adapter plug is not required.

- By carefully opening valve "Admission pressure / Vordruck" **3** you increase the system pressure. You can read the value via built-in pressure gauge **7**. Close the valve "Admission pressure / Vordruck" when the value of the test pressure is reached approximately.
- According to the required test pressure, place weights upon the measuring system **1** with due regard to the instructions (⇒ "Set of weights").



IMPORTANT!

Carefully place the weights onto the dead weight tester. All weights need to be applied separately. Never try to place and remove several weights or the entire stack on and from the dead weight tester respectively.

- Turn the red marking pointer of the reading device **2** towards the measuring system **1** for reading the measuring position. Make sure that the marking pointer does not impede the vertical movement of the measuring system.
- Open the valve "Measuring system / Messsystem" **5**.
- Set the measuring system with the weights into rotation by careful manual initiation and adjust the pressure with the adjusting mechanism **3** so that the centre measuring position is reached. Only if the measuring piston is kept floating, an equilibrium of forces is reached between weight force of the weights and the pneumatic counterforce. The test pressure is adjusted.



Please note!

Keep the time the measuring system rotates at the upper or lower stop as short as possible to avoid increased material wear. Stop the rotation prior to pressure relief.

- Open the valve "Test connection / Prüfanschluss" **4** and correct the system pressure with the adjusting mechanism **3** if necessary. Now, the adjusted pressure is applied at the test item.
- Compare the indication value of the test item and, if necessary, note the deviation from the applied actual pressure.



Please note!

The rotation of the measuring system minimises the influence of the static friction between measuring piston and measuring cylinder. Thus, a sensitive discrimination threshold is attained. A rotation of approximately 60 rpm is sufficient. Avoid excessive rotational speeds. Otherwise, the weights might fall down and might possibly damage the glass panel.

Pressure relief:

After completing the measuring process, ventilate the measuring system via valve "Ventilation / Entlüftung" **6**.

Operating Instructions

Dead Weight Tester PD 1



Set of weights:



IMPORTANT!

Please handle the weights with care and avoid all kinds of damage!

The set of weights is supplied in a separate transport case.

The weights and the base plate (basic load)  are marked with the pressure (in bar and kPa) they generate on the dead weight tester, with the instrument identification number and the full scale value. The base plate (basic load)  without any weights generates a pressure of 0.03 bar.

We recommend to use the supplementary weight to facilitate the application of further weights.

The supplementary weight is the weight 0.47 bar, which is a supplement to the basic load of 0.03 bar to generate 0.5 bar overpressure.

First, apply the supplementary weight (0.47 bar) and then further weights, according to the required test pressure. If pressure values lower than 0.5 bar shall be generated, the supplementary weight is not used.

The set of weights is comprised as follows:

| | |
|-----------|---------------------------------|
| 1 weight | 0.47 bar (supplementary weight) |
| 1 weight | 0.5 bar |
| 1 weight | 0.25 bar |
| 2 weights | 0.1 bar |
| 1 weight | 0.05 bar |
| 2 weights | 0.03 bar |
| 1 weights | 0.01 bar |

The smallest graduation of the supplied set of weights is 0.01 bar.

Correction weights for smaller graduations and for corrections of ambient parameter deviations of the standard conditions are available upon request.



Please note!

In order to avoid fingermarks, the individual weights should only be touched with clean cotton gloves. Any impurities can be removed with suitable degreasers.

6. Maintenance / Cleaning, Storage and Transport



CAUTION! Material damage and loss of warranty!

Any modifications or interventions in the device, made by the customer, might damage important parts or components. Such intervention leads to the loss of any warranty and manufacturer's responsibility!

→ Never modify the device or perform any repairs yourself.

Maintenance:

The instrument cannot be repaired by the operator.

In case of faults, which cannot be eliminated without interference in the device, please return the instrument to the manufacturer for repair. Any arising repairs may only be executed by the manufacturer.

Cleaning:

- Clean the dead weight tester with a dry or slightly dampened lint-free cloth.
- Do not use any sharp objects or aggressive agents for cleaning.

Storage and transport:

- Use the original packaging or comparable packaging for transport.
- Avoid impacts or strong vibrations.
- Protect the device against moisture, dust, direct sunlight and other heat sources.

7. Dismounting and Disposal

Before dismounting:

The test item must be unpressurised before dismounting! For this purpose, the valves should be open.

Disposal:



NO DOMESTIC WASTE!

The dead weight tester comprises various materials. It shall not be disposed of together with domestic waste.

→ Bring the dead weight tester to your local recycling plant

or

→ send the dead weight tester back to your supplier or to the ARMANO Messtechnik GmbH.

Operating Instructions

Dead Weight Tester PD 1

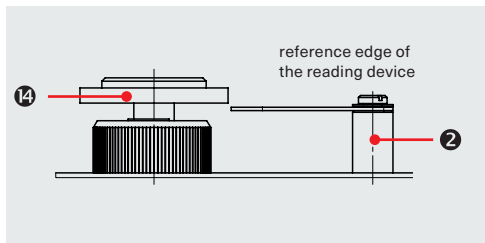

Fig. 1: reading device

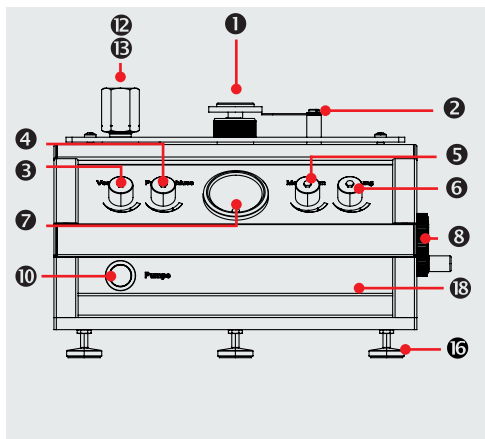

Fig. 2: front view

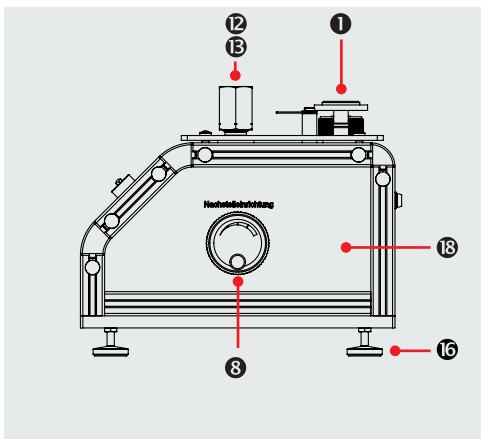

Fig. 3: lateral view, right

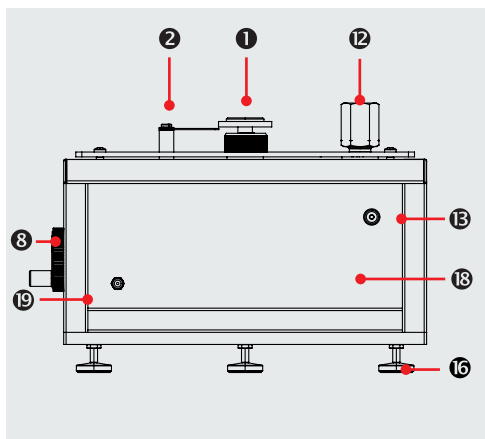

Fig. 4: back view

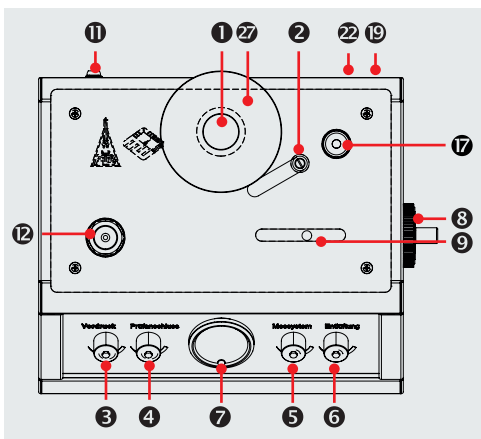

Fig. 5: top view

Operating Instructions

Dead Weight Tester PD 1

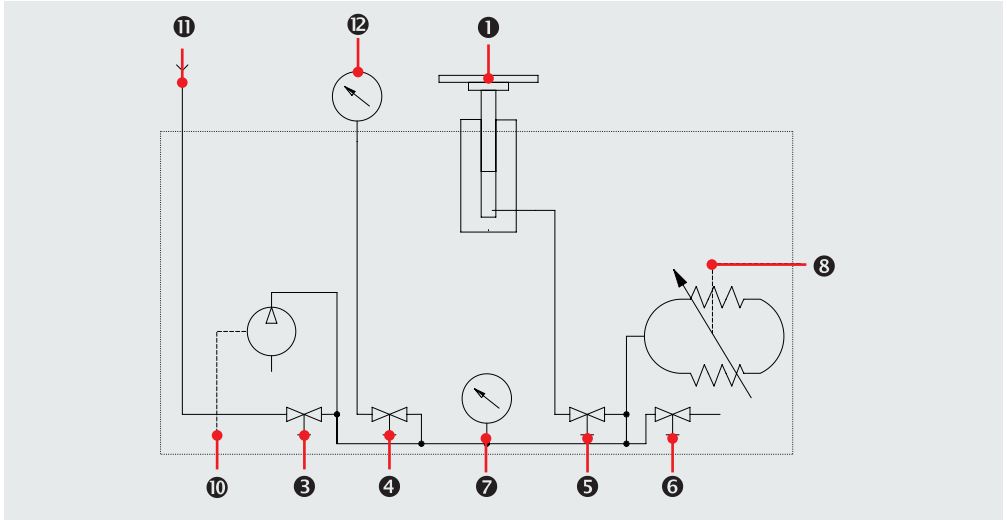

Fig. 6: schematic drawing

- | | | | |
|---|---|---|--|
| ① | Measuring system | ⑪ | “Connection admission pressure / Anschluss Vordruck” |
| ② | Reading device (stationary pointer) | ⑫ | Test connection |
| ③ | Stop valve “Admission pressure / Vordruck” | ⑬ | Clamping sleeve (AF 27) |
| ④ | Stop valve “Test connection / Prüfanschluss” | ⑭ | Base plate (basic load) |
| ⑤ | Stop valve “Measuring system / Messsystem” | ⑮ | Adjustable feet |
| ⑥ | Stop valve “Ventilation / Entlüftung” | ⑯ | Circular level |
| ⑦ | Mechanical admission pressure indication (pressure gauge) | ⑰ | Case |
| ⑧ | “Adjusting mechanism / Nachstelleinrichtung” | ⑱ | Electrical connection “6 V DC 500 mA” |
| ⑨ | Position indication adjusting mechanism | ⑳ | Nameplate |
| ⑩ | Push button “Pump / Pumpe” | ㉑ | Weights |

Legend

8. Declaration of Manufacturer

Herstellereklärung

Für die nachfolgend bezeichneten Erzeugnisse

VERGLEICHS-PRÜFPUMPEN

Typ PH 60-P gemäß Datenblatt 10151
Typ PS 60-P/PS 600-P gemäß Datenblatt 10155
Typ PS 60-G/PS 600-G gemäß Datenblatt 10156

und

KOLBEN-MANOMETER

Typ PD 1 gemäß Datenblatt 10311
Typ PD 6 gemäß Datenblatt 10312
Typ PD 10/PD 25 gemäß Datenblatt 10313
Typ PD 60/PD 100 gemäß Datenblatt 10315
Typ PD 600/PD 1000 gemäß Datenblatt 10316

Gemäß den Bestimmungen der Richtlinie

2014/68/EU (Druckgeräte-Richtlinie)

fallen diese Geräte nicht unter diese Richtlinie und werden weder einem Konformitätsbewertungsverfahren unterzogen noch mit einer CE-Kennzeichnung versehen.

Die Geräte werden nach geltender guter Ingenieurpraxis ausgelegt und gefertigt.

Declaration of Manufacturer

We hereby declare for the following named goods

COMPARISON PUMPS

Model PH 60-P according to data sheet 10151
Model PS 60-P/PS 600-P according to data sheet 10155
Model PS 60-G/PS 600-G according to data sheet 10156

and

DEAD WEIGHT TESTERS

Model PD 1 according to data sheet 10311
Model PD 6 according to data sheet 10312
Model PD 10/PD 25 according to data sheet 10313
Model PD 60/PD 100 according to data sheet 10315
Model PD 600/PD 1000 according to data sheet 10316

According to the regulations of the directive

2014/68/EU (Pressure Equipment Directive)

these instruments are not subject to this directive and neither do undergo a conformity assessment procedure nor do they bear the CE mark.

The instruments are designed and manufactured according to sound engineering practice.

121_Herstellereklärung Vergleichs-Prüfpumpen_Kolben-Manometer_Ausg. 08/18

Diese Erklärung wird verantwortlich für den Hersteller:
This declaration is issued under the sole responsibility of the manufacturer:

ARMANO Messtechnik GmbH

abgegeben durch/by
Grünhain-Beierfeld, 2018-09-21



Bernd Vetter
Geschäftsführender Gesellschafter / Managing Director

ARMANO

ARMANO Messtechnik GmbH

Standort Beierfeld

Am Gewerbepark 9

08344 Grünhain-Beierfeld

Tel.: +49 3774 58 – 0

Fax: +49 3774 58 – 545

mail@armano-beierfeld.com

Standort Wesel

Manometerstraße 5

46487 Wesel-Ginderich

Tel.: +49 2803 9130 – 0

Fax: +49 2803 1035

mail@armano-wesel.com

www.armano-messtechnik.de

Operating Instructions

Dead Weight Tester PD 1



ARMANO Messtechnik GmbH

Location Beierfeld

Am Gewerbepark 9
08344 Grünhain-Beierfeld
Tel.: +49 3774 58 – 0
Fax: +49 3774 58 – 545
mail@armano-beierfeld.com

Location Wesel

Manometerstraße 5
46487 Wesel-Ginderich
Tel.: +49 2803 9130 – 0
Fax: +49 2803 1035
mail@armano-wesel.com