



Contents

1.	Information on This Operating Instruction	1	10.	Annex	10
1.1	Pictographs Used	2	10.1	Pin Assignment of the Limit Switch Contact Assemblies	10
1.2	Exclusion of Liability	2	10.2	Contact Load of Electromechanical Limit Switch Contact Assemblies	12
1.3	General Information	2	11.	Declarations of Conformity	14
2.	Safety Instructions	2			
3.	Device Description	3			
3.1	Electromechanical Limit Switch Contact Assemblies	3			
3.2	Inductive Limit Switch Contact Assemblies	3			
3.3	Electronic Limit Switch Contact Assemblies	3			
3.4	Reed Switches	4			
4.	Application in Potentially Explosive Areas	4			
4.1	General Information	4			
4.2	Marking for the Potentially Explosive Area	5			
4.3	Special Conditions	6			
4.4	Standards Applied in the EU Type Examination Certificates	6			
5.	Technical Data	6			
5.1	Performance Data for Electromechanical Limit Switch Contact Assemblies	6			
5.2	Performance Data for Inductive Limit Switch Contact Assemblies	6			
5.3	Performance Data for Electronic Limit Switch Contact Assemblies	7			
5.4	Performance Data for Reed Switches	7			
6.	Mounting and Operation	7			
6.1	Mounting	7			
6.2	Mechanical Connection	8			
6.3	Electrical Connection	8			
6.4	Adjusting the Limit Setting Pointers	8			
6.4.1	Electromechanical, Inductive and Electronic Limit Switch Contact Assemblies	8			
6.4.2	Reed Switches	8			
7.	Maintenance / Cleaning, Storage and Transport	9			
8.	Dismounting and Disposal	9			
9.	CE Conformity	9			

1. Information on This Operating Instruction

- The manual is aimed at specialists and semi-skilled personnel.
- Please read the instructions carefully before carrying out any operation and keep the specified order.
- Thoroughly read and understand the information in chapter 2 "Safety Instructions".

If you have any problems or questions, please contact your supplier or contact us directly at:



ARMANO Messtechnik GmbH

Location Beierfeld

Am Gewerbestraße 9 • 08344 Grünhain-Beierfeld
Tel.: +49 3774 58 – 0 • Fax: +49 3774 58 – 545
mail@armano-beierfeld.com

Location Wesel

Manometerstraße 5 • 46487 Wesel-Ginderich
Tel.: +49 2803 9130 – 0 • Fax: +49 2803 1035
mail@armano-wesel.com

Operating Instructions Electric Limit Switch Contact Assemblies in Pressure and Temperature Measuring Instruments

1.1 Pictographs Used

In this manual, pictographs are used as hazard warnings.

Particular information, instructions and restrictions designed for the prevention of personal or substantial property damage:



WARNING! Is used to warn you against an imminent danger that may result in personal injury or death.

IMPORTANT! Is used to warn you against a possibly hazardous situation that may result in personal, property or environmental damage.

CAUTION! Is used to draw your attention to important recommendations to be observed. Disregarding them may result in property damage.



The following symbol highlights **actions** you have to conduct or **instructions** that have to be strictly observed.

1.2 Exclusion of Liability

We accept no liability for any damage or malfunction resulting from incorrect installation, inappropriate use of the device or failure to follow the instructions in this manual.

1.3 General Information

Please inspect the transport packaging and the delivered items immediately upon their receipt to determine their integrity and completeness. You have purchased an instrument that was manufactured according to high quality standards in our company, which is certified according to DIN ISO 9001.

2. Safety Instructions

Please read this operating instruction thoroughly before installing the device.

Disregarding the containing warnings, especially the safety instructions, may result in danger for people, the environment, and the device and the system it is connected to.

The ARMANO Messtechnik GmbH provides support for the use of its products either personally or via relevant literature. The customer verifies that our product is fit for purpose based on our technical information. The customer performs customer and application specific tests to ensure that the product is suitable for the intended use. With this verification, all hazards and risks are transferred to our customers. Our warranty expires in case of inappropriate use.

Qualified personnel:

The personnel that is charged for the installation, operation and maintenance of the instrument must hold a relevant qualification. This can be based on training or relevant tuition. The personnel must be aware of this manual and have access to it at all times.

General safety instructions:

- In all work, the existing national regulations for accident prevention and safety at the workplace must be complied with. Any internal regulations of the operator must also be complied with, even if these are not mentioned in this manual.
- Please regard relevant national and international safety instructions (ATEX 153, ExVo, BetrSichV etc.).
- All works must take place in a de-energised state.
- The instruments are not of the pressure sustaining type with a safety function in the sense of PED 2014/68/EU.
- Please do never manipulate the device! Otherwise, you will lose your warranty!
- Repairs may only be carried out by the manufacturer.
- Use the instrument in its perfect technical condition only. Damaged or defective instruments need to be checked immediately and replaced if necessary.
- Only use appropriate tools for mounting, connecting and dismantling the device.
- Nameplates or other information on the device shall neither be removed nor obliterated, since otherwise any warranty and manufacturer responsibility expires.

Operating Instructions Electric Limit Switch Contact Assemblies in Pressure and Temperature Measuring Instruments



IMPORTANT! Disregarding the respective regulations may result in severe personal injuries and / or property damage.



Special safety instructions:

Warnings, which are specifically relevant to individual operating procedures or activities, are to be found at the beginning of the relevant sections of this operating instruction.

3. Device Description

Electric limit switch contact assemblies are used for opening or closing connected electric circuits at the set limits.

Electric limit switch contact assemblies are directly built into the measuring instrument at factory. The built-in contact type is indicated on the nameplate of the measuring instrument. There, also switching function and pin assignment are shown schematically. The set points can be adjusted to the specific application.



Example: wiring diagram for contact M22

3.1 Electromechanical Limit Switch Contact Assemblies

Electromechanical limit switch contact assemblies are auxiliary current switches in compliance with DIN EN 60947-5-1 (IEC 947-5-1). Contact is made when the contacts are touching due to the movement of the actual value pointer, depending on the pressure change.

Low-action contact: type S
Magnetic contact: type M

The switching function is indicated by key figures.

S1/M1 = making contact when set point is exceeded in clockwise direction
S2/M2 = breaking contact when set point is exceeded in clockwise direction
S3/M3 = change-over when set point is exceeded in clockwise direction

Standards compliance: DIN EN 60947-1
DIN EN 60947-5-1

3.2 Inductive Limit Switch Contact Assemblies

Inductive limit switch contact assemblies are equipped with contact-free operating electrical proximity switches. The switching function is actuated by a control lug, which is moved by the actual value pointer within the area of the electromagnetic field of the slot-type initiator. When the set limits are exceeded, the electric circuits are opened or closed.

Type I1 = making contact when set point is exceeded in clockwise direction
Type I2 = breaking contact when set point is exceeded in clockwise direction

Standards compliance: DIN EN 60947-5-6
DIN EN 60947-5-2

3.3 Electronic Limit Switch Contact Assemblies

These inductive limit switch contact assemblies are equipped with switching amplifiers for direct control of evaluation units with low power, e.g. LPCs. Here, the advantages of inductive contacts are utilised, such as reliable contact making, no wear owing to the contact-free contact making, as well as a very low degree of retroaction on the measuring system. The electronic contact has been implemented for 2- or 3-wire connections with PNP output. The operating voltage range is 10...30 V DC, the maximum switching current is 100 mA.

Type E1 = making contact when set point is exceeded in clockwise direction, the output is activated
Type E2 = breaking contact when set point is exceeded in clockwise direction, the output becomes inactive

Operating Instructions Electric Limit Switch Contact Assemblies in Pressure and Temperature Measuring Instruments

3.4 Reed Switches

Reed switches are indirect bistable special switches for switching lowest signals. They are hermetically sealed and are actuated contact-free by a sufficiently strong magnetic field on the actual value pointer. They are mounted on a conductor plate turnable behind the dial.

Reed switch: type R

The switching function is indicated by key figures.

R1 = making contact	when set point is exceeded in clockwise direction
R2 = breaking contact	when set point is exceeded in clockwise direction
R3 = change-over	when set point is exceeded in clockwise direction
R4 = making contact	when set point is exceeded in counterclockwise direction
R5 = breaking contact	when set point is exceeded in counterclockwise direction

Installation Requirements:

Basically, DIN EN 837-2 "Selection and installation recommendations for pressure gauges" shall be regarded.

 Measuring instruments with reed switch must be protected against coarse contamination and high ambient temperatures variations.

 Reed switches are sensitive components, which are dependent on a magnetic field. Therefore, heavy mechanical vibrations or shocks as well as magnetic fields in close proximity are to be avoided. If necessary, the measuring instrument has to be mounted at a more appropriate location via flexible line.

However, if reed switches have the wrong switching status after the installation, this can be reversed by one-off pressurisation.

4. Application in Potentially Explosive Areas

4.1 General Information

For inductive limit switch contact assemblies, EU type examination certificates are available (available for download on our website):

Si...:	KEMA 02 ATEX 1090 X
SJ...:	PTB 99 ATEX 2219 X
	PTB 00 ATEX 2049 X

These types have been developed and approved for use in potentially explosive areas belonging to the intrinsic safety protection level in accordance with the following standards:

ATEX	IECEx
DIN EN 60079-0:2019	IEC 60079-0:2011
DIN EN 60079-11:2012	IEC 60079-11:2011
DIN EN 13463-1:2009	IEC n/a
DIN EN 13465-5:2003	IEC n/a



When using these types in potentially explosive areas, reduced values must be considered!

The temperature ranges, depending on the temperature class and further information, can be found in the type examination certificates.

The connection should only be effected with suitable equipment (e.g. switch amplifiers), which also meet the requirements of intrinsic safety. Intrinsic safety must always be ensured for the entire electric circuit!



The information provided in the EU type examination certificate, as well as the relevant rules and directives for the use or the intended application, must be considered.



Electrostatic charging of windows made of polycarbonate is to be avoided by all means.



The instrument must be protected against strong electromagnetic fields and mechanical damage.

Equipment, which is operated in potentially explosive areas, must not be modified.

Repairs on such equipment may only be executed by the manufacturer!

Operating Instructions Electric Limit Switch Contact Assemblies in Pressure and Temperature Measuring Instruments

4.2 Marking for the Potentially Explosive Area

Pressure gauges and thermometers with inductive limit switch contact assemblies are marked as follows:

Example:

Bourdon tube pressure gauge model RCh100 – 3, manufacturer ARMANO Messtechnik GmbH (The marking is available with both locations)

TURCK Si2-K08-Y1 (standard NCS 63, NCS 100)

ARMANO	ARMANO Messtechnik GmbH Manometerstraße 5 • 46487 Wesel
Bourdon Tube Pressure Gauge Type RCh 100 – 3	
	II 2G Ex ia IIC T6, T5, T4 Gb II 2D Ex ia IIIC T95°C, Db DEKRA 11 ATEX 0197 X IECEx DEK 11.0074 X
0344	
Slot Initiator Type Si2-K08-Y1 (TURCK)	
$U_{i\max} = 20 \text{ V DC}$ $I_{i\max} = 60 \text{ mA}$ $P_{i\max} = 130 \text{ mW}$	
$C_i = 250 \text{ nF}$ $L_i = 350 \mu\text{H}$	
-25 / +70 °C for T6	
-25 / +85 °C for T5	
-25 / +100 °C for T4	
-25 / +70 °C for T95 °C (dust)	

(content obligatory, free layout)

P+F SJ 3.5 N (standard NCS 160)

ARMANO	ARMANO Messtechnik GmbH Manometerstraße 5 • 46487 Wesel
Bourdon Tube Pressure Gauge Type RCh 100 – 3	
	II 2G Ex ia IIC T6, T5, T4 Gb II 2D Ex ia IIIC, T135°C Db DEKRA 11 ATEX 0197 X IECEx DEK 11.0074 X
0344	
Slot Initiator Type SJ3.5N (P+F)	
$U_{i\max} = 16 \text{ V DC}$ $I_{i\max} = 76 \text{ mA}$ $P_{i\max} = 242 \text{ mW}$	
$C_i = 50 \text{ nF}$ $L_i = 250 \mu\text{H}$	
-25 / +30 °C for T6	
-25 / +45 °C for T5	
-25 / +74 °C for T4	
-25 / +74 °C for T135 °C (dust)	

(content obligatory, free layout)

P+F SJ...SN (S1N) (option all NCS)

ARMANO	ARMANO Messtechnik GmbH Manometerstraße 5 • 46487 Wesel
Bourdon Tube Pressure Gauge Type RCh 100 – 3	
	II 2G Ex ia IIC T6, T5, T4 Gb II 2D Ex ia IIIC, T135°C Db DEKRA 11 ATEX 0197 X IECEx DEK 11.0074 X
0344	
Slot Initiator Type SJ...S(1)N (P+F)	
$U_{i\max} = 16 \text{ V DC}$ $I_{i\max} = 76 \text{ mA}$ $P_{i\max} = 242 \text{ mW}$	
$C_i = 30 \text{ nF}$ $L_i = 100 \mu\text{H}$	
-25 / +30 °C for T6	
-25 / +45 °C for T5	
-25 / +57 °C for T4	
-25 / +57 °C for T135 °C (dust)	

(content obligatory, free layout)

P+F SJ2-N (option NCS 63, NCS 100)

ARMANO	ARMANO Messtechnik GmbH Manometerstraße 5 • 46487 Wesel
Instrument Type, See List ***	
	II 2G Ex ia IIC T6, T5, T4 Gb II 2D Ex ia IIIC, T135°C Db DEKRA 11 ATEX 0197 X IECEx DEK 11.0074 X
 0344	
Slot Initiator Type SJ2-N (P+F)	
$U_{i\max} = 16 \text{ V DC}$ $I_{i\max} = 76 \text{ mA}$ $P_{i\max} = 242 \text{ mW}$	
$C_i = 30 \text{ nF}$ $L_i = 100 \mu\text{H}$	
-25 / +30 °C for T6	
-25 / +45 °C for T5	
-25 / +57 °C for T4	
-25 / +57 °C for T135 °C (dust)	

(content obligatory, free layout)

The switching function is marked as follows:

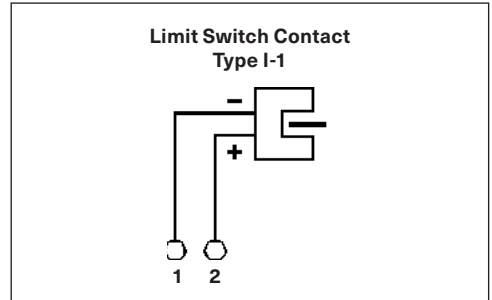

(content obligatory, free layout)

Operating Instructions Electric Limit Switch Contact Assemblies in Pressure and Temperature Measuring Instruments

4.3 Special Conditions

For versions with window made of polycarbonate:

When applied in an area that requires the use of equipment with protection level (EPL) Gb, electrostatic discharge of the window has to be avoided.

When applied in an area that requires the use of equipment with protection level (EPL) Db, extending brush discharges of the window have to be avoided.

4.4 Standards Applied in the EU Type Examination Certificates

The following applies to pressure gauges and thermometers with inductive limit switches:

Compliance with the essential health and safety requirements is ensured by compliance with
 DEKRA 11 ATEX 0197 X IECEx DEK 11.0074 X
 EN 60079-0:2012+A11:2013 IEC 60079-0:2011 (Ed.6)
 EN 60079-11:2011 IEC 60079-11:2011 (Ed.6)

5. Technical Data

Ambient conditions

Limit switch contact assemblies can be used in the range from $-20 / +70 \text{ }^{\circ}\text{C}$ ($-4 / +158 \text{ }^{\circ}\text{F}$)¹⁾, provided the temperatures specified for the basic instrument do not restrict this range. In such cases, the restricted values apply.

The degree of protection according to DIN EN 60529 depends on the case type of the basic instrument as you can read in its respective data sheet.

5.1 Performance Data for Electromechanical Limit Switch Contact Assemblies

Rated operating voltage	max. 250 V
Breaking capacity	10 W / 18 VA (low-action contact) 30 W / 50 VA (magnetic contact) 20 W / 20 VA (for oil-filled cases and magnetic contact)
Contact material	silver nickel 10 μ gold-plated (Ag80 Ni20 Au10 μ)

5.2 Performance Data for Inductive Limit Switch Contact Assemblies

Ambient temperature	$-20 / +70 \text{ }^{\circ}\text{C}$ ($-4 / +158 \text{ }^{\circ}\text{F}$) ¹⁾
Standards	DIN EN 60947-5-6 (NAMUR) DIN EN 60947-5-2 (EMC) IEC 61508 (SIL 2)

Type TURCK Si2-K08-Y1

(standard for NCS 63 – 100)

Slot width	2 mm
Nominal voltage U_0	8.2 V DC
Current consumption oscillator	
non-dampened	$\geq 2.1 \text{ mA}$
oscillator dampened	$\leq 1.2 \text{ mA}$
Switching frequency	2.5 kHz

Data for potentially explosive areas

Marking	II 1G Ex ia IIC T4...T6 Ga II 1D Ex ia IIIC T ₂₀₀ 135 $^{\circ}\text{C}$ Da
U_i	20 V DC ²⁾
I_i	60 mA ²⁾
P_i	130 mW ²⁾
C_i	250 nF
L_i	350 μH

Type P+F SJ 3.5 N

(standard for NCS 160)

Slot width	3.5 mm
Nominal voltage U_0	8.2 V DC
Current consumption oscillator	
non-dampened	$\geq 3 \text{ mA}$
oscillator dampened	$\leq 1 \text{ mA}$
Switching frequency	3 kHz

Data for potentially explosive areas

Marking	II 1G Ex ia IIC T6...T1 Ga II 1D Ex ia IIIC T ₂₀₀ 135 $^{\circ}\text{C}$ Da
U_i	16 V DC ²⁾
I_i	76 mA (Ga/Gb), 52 mA (Da) ²⁾
P_i	242 mW (Ga/Gb), 169 mW (Da) ²⁾
C_i	50 nF ²⁾
L_i	250 μH

These proximity switches must not be supplied via a type 4 supply circuit.

¹⁾ Important: Deviating values for potentially explosive applications!

²⁾ maximum values from the EU type examination certificates

Operating Instructions Electric Limit Switch Contact Assemblies in Pressure and Temperature Measuring Instruments

Type P+F SJ2(3.5)SN / S1N (option all NCS)

Slot width	2 (3.5) mm
Nominal voltage U_0	8.2 V DC
Current consumption oscillator	
non-dampened	≥ 3 mA
oscillator dampened	≤ 1 mA
Switching frequency	5 (3) kHz

Data for potentially explosive areas

Marking	II 1G Ex ia IIC T6...T1 Ga II 1D Ex ia IIIC T ₂₀₀ 135 °C Da
Ui	16 V DC ²⁾
Ii	76 mA ³⁾
Pi	242 mW ²⁾
Ci	30 nF ³⁾
Li	100 µH

Type P+F SJ2-N (option for NCS 63 – 100)

Slot width	2 (3.5) mm
Nominal voltage U_0	8.2 V DC
Current consumption oscillator	
non-dampened	≥ 3 mA
oscillator dampened	≤ 1 mA
Switching frequency	5 kHz

Data for potentially explosive areas

Marking	II 1G Ex ia IIC T6...T1 Ga II 1D Ex ia IIIC T ₂₀₀ 135 °C Da
Ui	16 V DC ²⁾
Ii	76 mA (Ga/Gb), 52 mA (Da) ²⁾
Pi	242 mW (Ga/Gb), 169 mW (Da) ²⁾
Ci	30 nF ³⁾
Li	100 µH

These proximity switches must not be supplied via a type 4 supply circuit.

5.3 Performance Data for Electronic Limit Switch Contact Assemblies

Operating voltage range	10...30 V DC
Reverse polarity protection	yes
EMC according to	DIN EN 60947-5-2
Output type	PNP
Switching action	making contact
Switching current	max. 100 mA
Residual current	max. 100 µA
Ambient temperature	-25 / +70 °C (-13 / +158 °F)

5.4 Performance Data for Reed Switches

Operating voltage range	max. 75 V DC / 50 VA
Breaking capacity	max. 10 W / 10 VA

Electromagnetic compatibility

Measuring instruments with inductive or electronic limit switch contact assemblies generally bear the CE-mark for electromagnetic compatibility. Measuring instruments with electromechanical limit switch contact assemblies and reed switches also bear the CE-mark, but with the restriction that not more than five switching cycles per minute may be performed.

6. Mounting and Operation

6.1 Mounting

First, check whether you have the right instrument for your specific application. The connection is mechanical as well as electrical.

The instruments must be mounted free of vibrations to avoid bouncing of closed switches.

In case of unstable measurement locations, the instrument can be mounted with a gauge holder (possibly in connection with a flexible line).

If vibrations cannot be avoided by suitable installation measures, instruments with a liquid filling must be used.

 Select the installation location so that coarse contamination, highly deviating ambient temperatures and vibrations are avoided.

²⁾ maximum values from the EU type examination certificates

³⁾ for one sensor circuit; 10 m long cable was taken into account

Operating Instructions Electric Limit Switch Contact Assemblies in Pressure and Temperature Measuring Instruments

6.2 Mechanical Connection

- According to the general technical regulations for pressure and temperature measuring instruments, e.g. DIN EN 837-2 or DIN EN 13190.
- Apply force at the wrench flats using a suitable tool.
- Do not apply the necessary force via case or terminal box.
- For safety pressure gauges (symbol S on the dial), keep a free space at the rear of at least 15 mm for blow-out back.

6.3 Electrical Connection

- Installation and electrical connection by qualified personnel only.
- Loosen plug connectors or terminal box by removing the centrally arranged fixing screw M3.
- Connect the cables using the screw connections.
- After completion of connection tighten the fixing screw hand-tight.

The assignment of the connections and the switching functions can be found in chapter 10 "Annex" and are indicated on the nameplate. Connecting terminals and ground terminal are marked accordingly.



The cable cross-sections must be designed for the maximum current consumption. The cable diameters must correspond to the nominal widths of the sealing inserts.

The instruments do not contain any overcurrent protection devices (recommendations ⇨ chapter 10 "Annex").

6.4 Adjusting the Limit Setting Pointers

6.4.1 Electromechanical, Inductive and Electronic Limit Switch Contact Assemblies



The set points are adjusted from the outside via an adjusting lock in the window.

With a separate or permanently fitted key (included with delivery), the limit setting pointers of the contact assemblies are set to the value at which the switching operation is to take place.

By pushing and simultaneously turning the adjusting key ① into the adjusting lock ③, the limit setting pointers ② can be set over the entire range of the dial.

For reasons of switching accuracy, switching reliability and service life of the measuring system, they should be set between 10 and 90 % of the respective measurement span.

The adjusting lock on instruments with a liquid filling must never be opened! The instruments might leak.



Should an adjustment of the limit setting pointers only be possible manually with detached window (special version) and without adjustable lock, it may only take place in de-energised condition.

6.4.2 Reed Switches

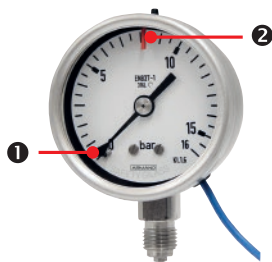

For the adjustment of a switching point, the device must be de-energised.

The adjustment of the set points is done manually from the inside after removing the bayonet ring, for the case versions "Fr" and "rFr" via removable key from the outside.

By moving the stationary pointer ② on the outer rim of the dial manually or with the removable key (⇨ chapter 6.4.1), the respective switch can be adjusted to the required set point. The adjustment range of the contacts is 10 to 90 % of the full scale value.

Operating Instructions Electric Limit Switch Contact Assemblies in Pressure and Temperature Measuring Instruments

7. Maintenance / Cleaning, Storage and Transport



CAUTION! Material damage and loss of warranty!

Any modifications or interventions in the device, made by the customer, might damage important parts or components. Such intervention leads to the loss of any warranty and manufacturer's responsibility!

→ Never modify the device or perform any repairs yourself.

Maintenance:

The instruments are maintenance-free.

To ensure measurement accuracy and reliability of the switching action, we recommend checking the instruments regularly (once or twice a year). For this, the instrument must be separated from the process and checked by using a pressure or temperature test device.

The instrument cannot be repaired by the operator. In case of faults, which cannot be eliminated without interference in the device, please return the instrument to the manufacturer for repair. Any arising repairs may only be executed by the manufacturer.

Cleaning:

- Clean the device with a dry or slightly dampened lint-free cloth.
- Before cleaning the interior of connector or cable box, they must be de-energised.
- Before switching the instrument on again, please make sure that all parts have properly dried.
- Do not use any sharp objects or aggressive agents for cleaning.

Storage and transport:

- Use the original packaging or comparable packaging for transport.
- Avoid impacts or strong vibrations.
- Protect the device against moisture, dust, direct sunlight and other heat sources.
- Permissible storage temperature: $-40 / +70$ °C ($-40 / +158$ °F).
- Before use, allow adaptation to the prevailing temperature.

8. Dismounting and Disposal

Before dismounting:

The instrument must be unpressurised before dismounting! Please remove the instrument completely from its application area.

Disposal:



NO DOMESTIC WASTE!

The device comprises various materials. It shall not be disposed of together with domestic waste.

→ Bring the device to your local recycling plant

or

→ send the device back to your supplier or to the ARMANO Messtechnik GmbH.

9. CE Conformity



The CE marking of the instruments certifies the conformity with prevailing EU directives for placing products on the market within the European Union. The following directives apply:

2014/68/EU (PED)

2014/30/EU (EMC)

2014/35/EU (Low-voltage directive)

2014/34/EU (ATEX)

The corresponding declarations of conformity are enclosed or available upon request.

Operating Instructions Electric Limit Switch Contact Assemblies in Pressure and Temperature Measuring Instruments

10. Annex

10.1 Pin Assignment of the Limit Switch Contact Assemblies

Low-action and magnetic contact

NCS 63 – 160

(based on DIN 16085/16196)

Version			Pin assignment			
Model	Type		Standard	2 separated circuits	3 separated circuits	
Mx	1-fold		1 + 4	-	-	
M3	single change-over	make contact	1 + 4	-	-	
		break contact	2 + 4	-	-	
Mxx	2-fold	1 st contact	1 + 4	1 + 2	-	
		2 nd contact	2 + 4	3 + 4	-	
M33	double change-over	1 st change-over				
		make contact	1 + 4	1 + 4	-	
		break contact	2 + 4	2 + 4	-	
		2 nd change-over				
		make contact	5 + 4	5 + 3	-	
Mxxx	3-fold	break contact	6 + 4	6 + 3	-	
				1 st separated	2 nd separated	
		1 st contact	1 + 4	1 + 2	1 + 4	1 + 2
		2 nd contact	2 + 4	3 + 5	2 + 4	3 + 4
Mxxxx	4-fold	3 rd contact	3 + 4	4 + 5	5 + 6	5 + 6
		1 st contact	1 + 6	-	-	-
		2 nd contact	2 + 6	-	-	-
		3 rd contact	3 + 6	-	-	-
		4 th contact	4 + 6	-	-	-

Operating Instructions Electric Limit Switch Contact Assemblies in Pressure and Temperature Measuring Instruments

Inductive contact
(based on DIN 16085 / 16196)

NCS 63 – 160

Version		Pin assignment		
Model	Type		Clamp	Polarity
lx	1-fold		1	-
			2	+
lxx	2-fold	1 st contact	1	-
			2	+
		2 nd contact	3	-
			4	+
lxxx	3-fold	1 st contact	1	-
			2	+
		2 nd contact	3	-
			4	+
		3 rd contact	5	-
			6	+
lxxxx	4-fold		cable box left	
		1 st contact	1	-
			2	+
		2 nd contact	3	-
			4	+
			cable box right	
		3 rd contact	1	-
			2	+
		4 th contact	3	-
			4	+

Electronic contact (3-wire version)

NCS 63 – 160

Version		Pin assignment			
Model	Type	Clamp		Connection	
Ex	1-fold		1	+	
			2	-	
			3	(contact)	A
Exx	2-fold		1	+	
			2	-	
			3	(1 st contact)	A
			4	(2 nd contact)	A
Exxx	3-fold		1	+	
			2	-	
			3	(1 st contact)	A
			4	(2 nd contact)	A
			5	(3 rd contact)	A
Exxxx	4-fold		1	+	
			2	-	
			3	(1 st contact)	A
			4	(2 nd contact)	A
			5	(3 rd contact)	A
			6	(4 th contact)	A

Operating Instructions Electric Limit Switch Contact Assemblies in Pressure and Temperature Measuring Instruments

Electronic contact (2-wire version)

NCS 63 – 160

Version		Pin assignment		
Model	Type	Clamp		Connection
Ex	1-fold	1		-
		4		+
Exx	2-fold	1	(1 st contact)	-
		2	(2 nd contact)	-
		4		+
Exxx	3-fold	1	(1 st contact)	-
		2	(2 nd contact)	-
		3	(3 rd contact)	-
		4		+
Exxxx	4-fold	1	(1 st contact)	-
		2	(2 nd contact)	-
		3	(3 rd contact)	-
		4	(4 th contact)	-
		6		+

Reed contact

NCS 63

Version		Pin assignment		
Model	Type		Plug	Cable
Rx	1-fold		1 + 2	bl + bn
R3	single change-over	make contact		1 + 3
		break contact		2 + 3
Rxx	2-fold	1 st contact	1 + 3	1 + 2
		2 nd contact	2 + 3	3 + 4

Micro switch

NCS 100

(based on DIN 16085 / 16196)

Version		Pin assignment	
Model	Type		
MS	single change-over	make contact	1 + 4
		break contact	2 + 4

10.2 Contact Load of Electromechanical Limit Switch Contact Assemblies

Contact load limits for ohmic loads (according to DIN EN 60947-5-1:1991)

	Low-action contact	Magnetic contact	
		gas filled devices	liquid filled devices
Rated insulation voltage	60 < U _I < 250 V	60 < U _I < 250 V	60 < U _I < 250 V
Rated operating voltage U _{eff}	max. 250 V	max. 250 V	max. 250 V
Nominal operational current:			
switch-on current	0.7 A	1.0 A	1.0 A
breaking current	0.7 A	1.0 A	1.0 A
continuous current	0.6 A	0.6 A	0.6 A
Breaking capacity	10 W / 18 VA	30 W / 50 VA	20 W / 20 VA

For contacts with slight spirals, the nominal operational currents must be halved due to the low cross-section of the spring (this applies to special versions, which are not listed in the data sheets).

None of the limit values for voltage, current and power must be exceeded.

Operating Instructions Electric Limit Switch Contact Assemblies in Pressure and Temperature Measuring Instruments

Recommended contact load for ohmic and inductive load

Voltage acc. to DIN IEC 60038	Low-action contact			Magnetic contact					
	ohmic load		inductive load	gas filled devices			liquid filled devices		
				ohmic load		inductive load	ohmic load		inductive load
DC voltage / AC voltage	DC	AC	AC $\phi > 0.7$	DC	AC	AC $\phi > 0.7$	DC	AC	AC $\phi > 0.7$
V	mA	mA	mA	mA	mA	mA	mA	mA	mA
230	40	45	25	100	120	65	65	90	40
110	80	90	45	200	240	130	130	180	85
48	120	170	70	300	450	200	190	330	130
24	200	350	100	400	600	250	250	150	150

Recommended values for overcurrent protection devices (according to DIN EN 60947-5-1)¹⁾

Voltage	Magnetic contact nominal case size			Low-action contact nominal case size		
V	63	100	160	63	100	160
24	1 A	2 A	2 A	0.63 A	1 A	1 A
250	0.63 A	1 A	1 A	0.125 A	0.315 A	0.315 A

For contacts with slight spirals, these values must be halved (this applies to special versions, which are not listed in the data sheets).

Pulse Controlled Multifunctional Relays, Type MSR

Multifunctional relays serve the purpose of increasing the breaking capacity, as the control circuit is of the low voltage type.

Very frequently, the breaking capacity of electromechanical limit switch contact assemblies is exceeded, resulting in rapid wear of the contact pins and thus leading to hazardous functional impairments.

When using limit switch contact assemblies in oil (this relates only to magnetic contacts), difficulties regarding switching reliability, service life of the contacts and oil contamination can occur.

In oil-filled contact pressure gauges or thermometers, the oil combusts with the occurring switching spark, which results in the oil turning turbid on the one hand, and in the charring of the contacts on the other hand. By using our pulse controlled multifunctional relays, these problems can be avoided. The service life of the limit switch contact assemblies is considerably increased, as the opening and closing of the contacts is effected to 99 % in a de-energised condition. Moreover, flutter effects are almost entirely prevented due to the time behaviour of the relay.

¹⁾ The values refer to semi-time lag fuses and a maximum short-circuit current of 100 A.

Operating Instructions Electric Limit Switch Contact Assemblies in Pressure and Temperature Measuring Instruments

11. Declarations of Conformity

EU-Konformitätserklärung

EU Declaration of Conformity

Für die nachfolgend bezeichneten Erzeugnisse

We hereby declare for the following named goods

MANOMETER NG 63 MIT REEDKONTAKT

PRESSURE GAUGES NCS 63 WITH REED SWITCH

wird hiermit bestätigt, dass sie den wesentlichen Schutzanforderungen entsprechen, die in der Richtlinie des Rates zur Angleichung der Rechtsvorschriften der Mitgliedstaaten über die elektromagnetische Verträglichkeit (2014/30/EU) festgelegt sind.

that they meet the essential protective requirements, which have been fixed in the Directive of the European Parliament and the Council on the approximation of the laws of the Member States relating to the electromagnetic compatibility (2014/30/EU).

Sie fallen nicht unter die Niederspannungsrichtlinie (2014/35/EU), da sie nur mit Spannungen unter 50 V AC bzw. 75 V DC betrieben werden dürfen.

They are not subject to the Low Voltage Directive (2014/35/EU) since they may be used with voltages below 50 V AC or 75 V DC only.

Diese Erklärung gilt für alle Exemplare, die nach den anhängenden Datenblättern 1211.94 und 1610.94 – welche Bestandteil dieser Erklärung sind – hergestellt werden.

This declaration applies to any specimen manufactured according to the attached data sheets 1211.94 and 1610.94, which are part of this declaration.

Zur Beurteilung der Erzeugnisse hinsichtlich der o. a. Richtlinien wurden folgende Normen herangezogen:

The following standards have been used to assess the goods regarding the aforementioned directives:

DIN EN 60947-1: 2015-09
DIN EN 60947-5-1: 2010-04
DIN EN 61010-1: 2011-07

Die Geräte werden nach geltender guter Ingenieurpraxis ausgelegt und gefertigt. Des Weiteren fallen Manometer mit einem Messbereichsendwert > 0,5 bar als „druckhaltende Ausrüstungsteile“ unter die

The instruments are designed and manufactured according to sound engineering practice. Moreover, pressure gauges with upper range values >0.5 bar are, as pressure equipment parts, subject to

Druckgeräterichtlinie (2014/68/EU)

Pressure Equipment Directive (2014/68/EU)

Soweit zutreffend erstreckt sich die CE-Kennzeichnung dann auch auf diese Richtlinie. Die Konformität wird in gesonderten Erklärungen bestätigt.

As far as they are concerned, the CE-marking then also applies to this directive. The conformity is certified in separate declarations.

Diese Erklärung wird verantwortlich für den Hersteller:

This declaration is issued under the sole responsibility of the manufacturer.

ARMANO Messtechnik GmbH

abgegeben durch/by
Grünhain-Beierfeld, 2021-04-15

Bernd Vetter
Geschäftsführender Gesellschafter / Managing Director

ARMANO

ARMANO Messtechnik GmbH

Standort Beierfeld

Am Gewerbestraße 9
08344 Grünhain-Beierfeld
Tel.: +49 3774 58 – 0
Fax: +49 3774 58 – 545
mail@armano-beierfeld.com

Standort Wesel

Manometerstraße 5
46487 Wesel-Ginderich
Tel.: +49 2803 9130 – 0
Fax: +49 2803 1035
mail@armano-wesel.com

www.armano-messtechnik.de

EU-Konformitätserklärung

EU Declaration of Conformity

Für die nachfolgend bezeichneten Erzeugnisse

We hereby declare for the following named goods

MANOMETER UND THERMOMETER mit elektromechanischen (M, S), induktiven (I) oder elektronischen (E) Grenzsensigalgebern

PRESSURE GAUGES AND THERMOMETERS with electromechanical (M, S), inductive (I) or electronic (E) limit switch contacts

wird hiermit erklärt, dass sie den wesentlichen Schutzanforderungen entsprechen, die in der nachfolgend bezeichneten Richtlinie festgelegt sind:

that they meet the essential protective requirements, which have been fixed in the following directives:

RICHTLINIE 2014/30/EU DES EUROPÄISCHEN PARLAMENTS UND DES RATES vom 26. Februar 2014 zur Angleichung der Rechtsvorschriften der Mitgliedstaaten über die elektromagnetische Verträglichkeit – kurz: **EMV-Richtlinie**
Die Geräte werden nach geltender guter Ingenieurpraxis ausgelegt und gefertigt. (nicht M, S)

DIRECTIVE 2014/30/EU OF THE EUROPEAN PARLIAMENT AND THE COUNCIL from February 26, 2014 on the approximation of the laws of the Member States relating to the electromagnetic compatibility – short: **EMC Directive**
The instruments are designed and manufactured according to sound engineering practice. (not M, S)

RICHTLINIE 2014/35/EU DES EUROPÄISCHEN PARLAMENTS UND DES RATES vom 26. Februar 2014 über elektrische Betriebsmittel zur Verwendung innerhalb bestimmter Spannungsgrenzen (nicht I, E) – kurz: **Niederspannungsrichtlinie**

DIRECTIVE 2014/35/EU OF THE EUROPEAN PARLIAMENT AND THE COUNCIL from February 26, 2014 on electrical equipment designed for the use within certain voltage limits (not I, E) – short: **Low Voltage Directive**

RICHTLINIE 2011/65/EU DES EUROPÄISCHEN PARLAMENTS UND DES RATES vom 08. Juni 2011 zur Beschränkung der Verwendung bestimmter gefährlicher Stoffe in Elektro- und Elektronikgeräten – kurz: **RoHS-Richtlinie**

DIRECTIVE 2011/65/EU OF THE EUROPEAN PARLIAMENT AND THE COUNCIL from June 8, 2011 on the restriction of the use of certain hazardous substances in electrical and electronic equipment – short: **RoHS Directive**

Des Weiteren fallen Manometer mit Messbereichsendwerten >200 bar oder Flanschanschlüssen >DN 25 und Messbereichsendwerten >0,5 bar als „Druckhaltende Ausrüstungsteile“ unter die **RICHTLINIE 2014/68/EU DES EUROPÄISCHEN PARLAMENTS UND DES RATES vom 15. Mai 2014** über Druckgeräte – kurz: **Druckgeräterichtlinie**

Moreover, pressure gauges with upper range values >200 bar or flange connections >DN 25 and upper range values >0.5 bar are, as pressure equipment parts, subject to **DIRECTIVE 2014/68/EU OF THE EUROPEAN PARLIAMENT AND THE COUNCIL from May 15, 2014** relating to pressure equipment – short: **Pressure Equipment Directive**

Soweit zutreffend erstreckt sich die CE-Kennzeichnung dann auch auf diese Richtlinie. Die Konformität wird in gesonderten Erklärungen bestätigt.

As far as they are concerned, the CE-marking then also applies to this directive. The conformity is certified in separate declarations.

Zur Beurteilung des Erzeugnisses hinsichtlich der Richtlinien wurden folgende Normen herangezogen:

The following standards have been used to assess the goods regarding the directives:

Norm: Standard:	Richtlinienbezug Reference to directive
DIN EN 60947-5-2:2014-01 DIN EN 60947-5-6:2000-12	EMV-Richtlinie 2014/30/EU EMC Directive 2014/30/EU
DIN EN 60947-1:2015-09 DIN EN 60947-5-1:2010-04	Niederspannungsrichtlinie 2014/35/EU Low Voltage Directive 2014/35/EU
DIN EN 837-1:1997-02 DIN EN 837-3:2019-08	Druckgeräterichtlinie 2014/68/EU Pressure Equipment Directive 2014/68/EU
DIN EN 12952-11 2007	Wasserröhrenkessel und Anlagenkomponenten – Teil 11: Anforderungen an Begrenzungseinrichtungen an Kessel und Zubehör Water-tube boilers and auxiliary installations - Part 11: Requirements for limiting devices of the boiler and accessories

Diese Erklärung wird verantwortlich für den Hersteller:
This declaration is issued under the sole responsibility of the manufacturer:

ARMANO Messtechnik GmbH

abgegeben durch/by
Grünhain-Beierfeld, 2022-10-17



Bernd Vetter
Geschäftsführender Gesellschafter / Managing Director

ARMANO

ARMANO Messtechnik GmbH

Standort Beierfeld

Am Gewerbpark 9

08344 Grünhain-Beierfeld

Tel.: +49 3774 58 – 0

Fax: +49 3774 58 – 545

mail@armano-beierfeld.com

Standort Wesel

Manometerstraße 5

46487 Wesel-Ginderich

Tel.: +49 2803 9130 – 0

Fax: +49 2803 1035

mail@armano-wesel.com

Operating Instructions Electric Limit Switch Contact Assemblies in Pressure and Temperature Measuring Instruments

EU-Konformitätserklärung

EU Declaration of Conformity

Für die nachfolgend bezeichneten Erzeugnisse

We hereby declare for the following named goods

MANOMETER

Typen RCh..., RSCh..., RQ..., PCh..., PSCh..., DiRZCh...

PRESSURE GAUGE

Models RCh..., RSCh..., RQ..., PCh..., PSCh..., DiRZCh...

THERMOMETER

Typen TSCh..., TGeCh..., TF..., TRCh...

THERMOMETER

Models TSCh..., TGeCh..., TF..., TRCh...

mit induktiven Grenzsingalgebern

with Limit Switch Contact Assemblies with Inductive Contacts

wird hiermit erklärt, dass sie den wesentlichen Schutzanforderungen entsprechen, die in der nachfolgend bezeichneten Richtlinie festgelegt sind:

that they meet the essential protective requirements, which have been fixed in the following directives:

RICHTLINIE 2014/34/EU DES EUROPÄISCHEN PARLAMENTS UND DES RATES vom 26. Februar 2014 für Geräte und Schutzsysteme zur bestimmungsgemäßen Verwendung in explosionsgefährdeten Bereichen – kurz:

DIRECTIVE 2014/34/EU OF THE EUROPEAN PARLIAMENT AND THE COUNCIL from February 26, 2014 relating to equipment and protective systems intended for use in potentially explosive atmospheres – short:

ATEX-Richtlinie

ATEX Directive

Zur Beurteilung der Erzeugnisse hinsichtlich der Richtlinie wurden folgende Normen herangezogen:

The following standards have been used to assess the goods regarding the directive:

DIN EN 60079-0:2012+A11:2013¹⁾
DIN EN 60079-11:2011¹⁾

Kennzeichnung:



II 2G Ex ia IIC T4...T6 Gb
II 2D Ex ia IIIC T95 °C...T135 °C Db

Marking:



II 2G Ex ia IIC T4...T6 Gb
II 2D Ex ia IIIC T95 °C...T135 °C Db

Benannte Stelle für EU-Baumusterprüfbescheinigung und Überwachung Qualitätsmanagement:
DEKRA Certification B. V.
Meander 1051
6802 ED Arnhem, NIEDERLANDE
Kennnummer: **0344**

Notified body for EU-Type Examination and quality management assessment:
DEKRA Certification B. V.
Meander 1051
6802 ED Arnhem, NETHERLANDS
Identification number: **0344**

EU-Baumusterprüfbescheinigung:

EU-Type Examination Certificate:

DEKRA 11 ATEX 0197 X

105 EU-Konformitätserklärung/ATEX RHM/PM/DA/K_T/mil./GSG-Ausg. 02/24

¹⁾ Der Hersteller erklärt, dass diese Produkte mit den aktuellsten Ausgaben der Normen übereinstimmen. Die Änderungen der letzten Ausgaben wurden geprüft und haben keine Auswirkungen auf die Produkte.

¹⁾ The manufacturer declares that these products comply with the latest editions of the standards. The changes to the latest editions have been checked and have no effect on the products.

Diese Erklärung wird verantwortlich für den Hersteller.
This declaration is issued under the sole responsibility of the manufacturer:

ARMANO Messtechnik GmbH

abgegeben durch / by
Grünhain-Beierfeld, 2024-02-14

Bernd Vetter
Geschäftsführender Gesellschafter / Managing Director

ARMANO

ARMANO Messtechnik GmbH

Standort Beierfeld

Am Gewerbeplatz 9
08344 Grünhain-Beierfeld
Tel.: +49 3774 58 – 0
Fax: +49 3774 58 – 545
mail@armano-beierfeld.com

Standort Wesel

Manometerstraße 5
46487 Wesel-Ginderich
Tel.: +49 2803 9130 – 0
Fax: +49 2803 1035
mail@armano-wesel.com

www.armano-messtechnik.de